

I.O.M. #081 updated : 09/19/2014

INSTRUCTION MANUAL • INSTALLATION • OPERATION • MAINTENANCE

SENTRA

TEMPERATURE CONTROLLER

TM

"SK" Series



Covers Models with 'HE' Series Instrument.



ADVANTAGE ENGINEERING, INC.
525 East Stop 18 Road Greenwood, IN 46142
317-887-0729 fax: 317-881-1277
Service Department fax: 317-885-8683
www.AdvantageEngineering.com
E-mail: sales@AdvantageEngineering.com

SENTRA

TEMPERATURE CONTROLLER

™ *"SK" Series*

INSTRUCTION MANUAL SENTRA 'SK' 'HE' SERIES INSTRUMENT

COVERING

INSTALLATION OPERATION MAINTENANCE



ADVANTAGE ENGINEERING, INC. 525 East Stop 18 Road Greenwood, IN 46142
317-887-0729 fax: 317-881-1277 Service Department fax: 317-885-8683
www.AdvantageEngineering.com E-mail: sales@AdvantageEngineering.com

TABLE OF CONTENTS

| | |
|--------------------------------------------------------|-----------|
| SENTRA QUICK START-UP GUIDE | 6 |
| SENTRA "QUICK" TROUBLESHOOTING GUIDE | 7 |
| 1.0 GENERAL | 9 |
| 1.1 Introduction | 10 |
| 1.2 Safety | 10 |
| 1.3 Receiving Instructions | 11 |
| 1.4 Efficiency | 11 |
| 1.5 Water Treatment | 12 |
| 1.6 Components | 12 |
| 2.0 INSTALLATION | 15 |
| 2.1 General | 16 |
| 2.2 To and from process connections | 16 |
| 2.3 Water supply connection | 17 |
| 2.4 Drain connection | 17 |
| 2.5 Electrical connection | 18 |
| 3.0 START UP SEQUENCE | 23 |
| 3.1 General | 24 |
| 3.2 System fill/operations procedure | 24 |
| 3.3 Instrument operation | 30 |
| 3.4 Shut down/disconnect sequence | 41 |
| 4.0 TROUBLESHOOTING | 43 |
| 4.1 Unit will not start (Power light off) | 44 |
| 4.2 Unit will not start (Power light on) | 44 |
| 4.3 Unit stops | 45 |
| 4.4 Unit overheats | 45 |
| 4.5 Unit underheats | 47 |
| 4.6 Pressure relief valve leaks | 47 |
| 4.7 Cooling valve fault | 48 |
| 5.0 MAINTENANCE | 49 |
| 5.1 Pump seal replacement | 50 |
| 5.2 Heating cylinder replacement | 53 |
| 5.3 AVT™ modulating valve service | 55 |
| 5.4 Probe calibration | 58 |
| 5.5 Voltage changeover | 61 |
| 5.6 Sensor probe service | 64 |
| 5.7 Pressure switch service | 66 |
| 5.8 Instrument service | 67 |
| 5.9 Electronic Instrument Repair Policy & Procedure | 69 |
| 5.10 Flow meter service | 70 |
| 6.0 SENTRA COMPONENTS | 73 |
| 6.1 Mechanical system | 74 |
| 6.2 Electrical system | 76 |



| | | |
|------------|-----------------------------------------------|-----------|
| 7.0 | RELATED DRAWINGS | 79 |
| 7.1 | Sentra physical | 80 |
| 7.2 | Sentra electrical | 81 |
| 7.3 | Sentra circuit schematic | 82 |
| 7.4 | Sentra regulator/bypass installation | 83 |
| 7.5 | Sentra dual zone dolly | 84 |
| 7.6 | Sentra stacking rack | 85 |
| | | |
| 8.0 | APPENDIX | 87 |
| 8.1 | Sentra model # and suffix coding | 89 |
| 8.2 | Interpretation of process pressure gauges | 90 |
| 8.3 | Mold purge operation | 91 |
| 8.4 | Closed circuit operation | 92 |
| 8.5 | DIP switch setup | 93 |
| 8.6 | Advanced Instrument Use | 94 |
| 8.7 | SPI commands | 96 |
| 8.8 | Communications cable | 99 |
| 8.9 | Second setpoint operation | 100 |
| 8.10 | Optional alarm operation | 101 |
| 8.11 | AVT™ valve components | 102 |
| 8.12 | Sentra AS5 pump parts list - 1/2 HP to 1 HP | 103 |
| 8.13 | Sentra AS5 pump parts list - 1 1/2 HP to 3 HP | 104 |
| 8.14 | Sentra parts list - HE instrument | 105 |

SENTRA 'QUICK' START-UP GUIDE

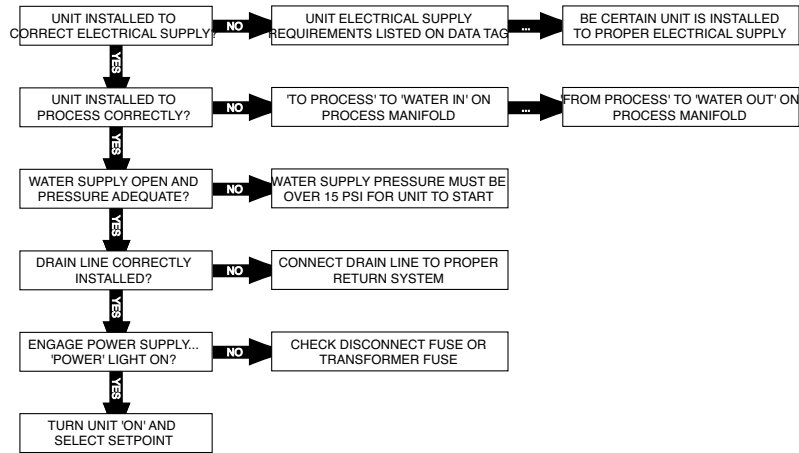

QUICK TROUBLESHOOTING GUIDE

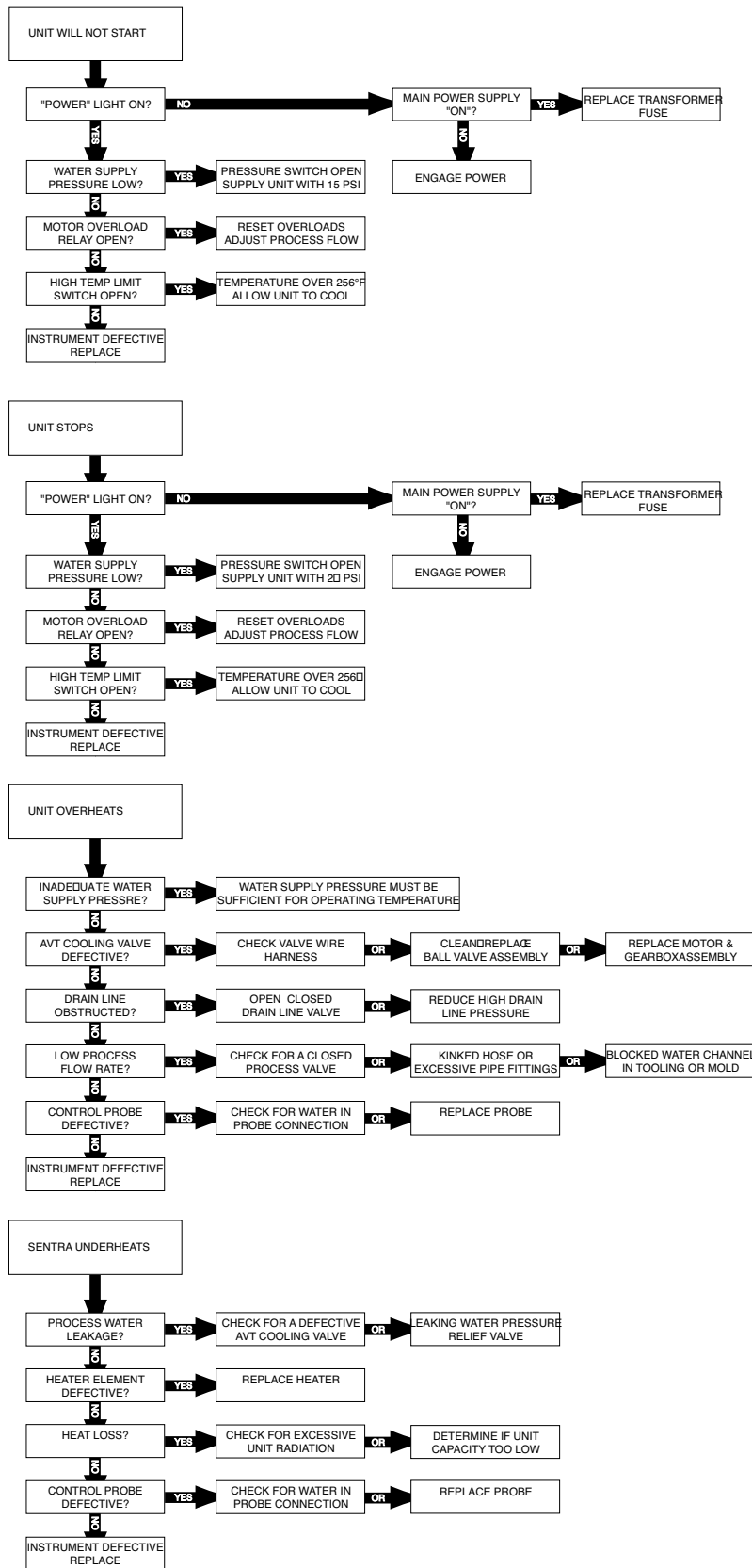

THIS PAGE INTENTIONALLY BLANK

1.0 GENERAL

- 1.1 INTRODUCTION**
- 1.2 SAFETY**
- 1.3 RECEIVING INSTRUCTIONS**
- 1.4 EFFICIENCY**
- 1.5 WATER TREATMENT**
- 1.6 COMPONENTS**



1.1 INTRODUCTION

- A. This manual covers temperature control units from 10 to 34 kW) of heating capacity using the Sentra 'HE' Series microprocessor control instrument. The standard fluid operating temperature range for this temperature control unit is 30°F to 250°F for units. Consult the factory if you have questions about the operating range of your temperature control unit.
- B. The intent of this manual is to serve as a guide in the installation, operation and maintenance of your temperature control unit. Improper installation can lead to equipment damage and poor performance. Failure to follow the installation, operation and maintenance instructions may result in damage to the unit that is not covered under the limited warranty. This manual is for standard products. The information contained in this manual is intended to be general in nature. The information is typical only and may not represent the actual unit purchased.
- C. When calling for assistance from the Manufacturer's Service Department, it is important to know the model and serial number of the particular unit. The model number includes critical unit information which is helpful when troubleshooting operating difficulties. The serial number allows the service team to locate manufacturing and testing records which can have additional information relating to a particular unit.

1.2 SAFETY

- A. It is important to become thoroughly familiar with this manual and the operating characteristics of the unit.
- B. It is the owner's responsibility to assure proper operator training, installation, operation, and maintenance of the unit.
- C. Observe all warning and safety placards applied to the chiller. Failure to observe all warnings can result in serious injury or death to the operator and severe mechanical damage to the unit.
- D. Observe all safety precautions during installation, startup and service of this equipment due to the presence of high voltage and refrigerant charge. Only qualified personnel should install, startup and service this equipment.
- E. When working on this equipment, observe precautions in literature and on tags, stickers and labels located on the equipment. Wear work gloves and safety glasses.



WARNING: *This equipment contains hazardous voltages that can cause severe injury or death. Disconnect and lock out incoming power before installing or servicing the equipment.*



1



2



3

Samples of Warning Labels applied to typical temperature control units.

1. Alerts users to the danger of high voltage.
2. Alerts the user to possible explosive danger.
3. Alerts the user to a hot surface danger due to high operating temperatures.

1.3 RECEIVING INSTRUCTIONS

- A. Temperature control units are shipped skid mounted and wrapped in plastic prior to shipment. Check the overall condition of the equipment prior to accepting delivery.
- B. Check for visible damage and document any evident damage on the delivery receipt. Shipping damage is the responsibility of the carrier.
- C. In order to expedite payment for damages, should they occur, follow proper procedures and keep detailed records. Take photographs of any suspected damage.

1.4 EFFICIENCY

- A. Long term efficiency of operation is largely determined by proper maintenance of the mechanical parts of the unit and the water quality. The Manufacturer recommends filtering the process water to prevent solids from plugging critical parts.
- B. The Manufacturer highly recommends that the services of a qualified water treatment specialist be obtained and their recommendations be followed. The Manufacturer accepts no responsibility for inefficient operation, or damage caused by foreign materials or failure to use adequate water treatment.



WARNING: Improper water treatment will void unit warranty.

1.5 WATER TREATMENT

- A. The use of untreated or improperly treated water in a portable chiller may result in scaling, erosion, corrosion, algae or slime.
- B. It is recommended that the services of a qualified water treatment specialist be engaged to determine what water treatment is required.
- C. Advantage assumes no responsibility for equipment failures which result from untreated or improperly treated water.
- D. Do not use deionized water in this unit. Some customized units may be compatible with deionized water. Consult the factory before using deionized water.

1.6 COMPONENTS

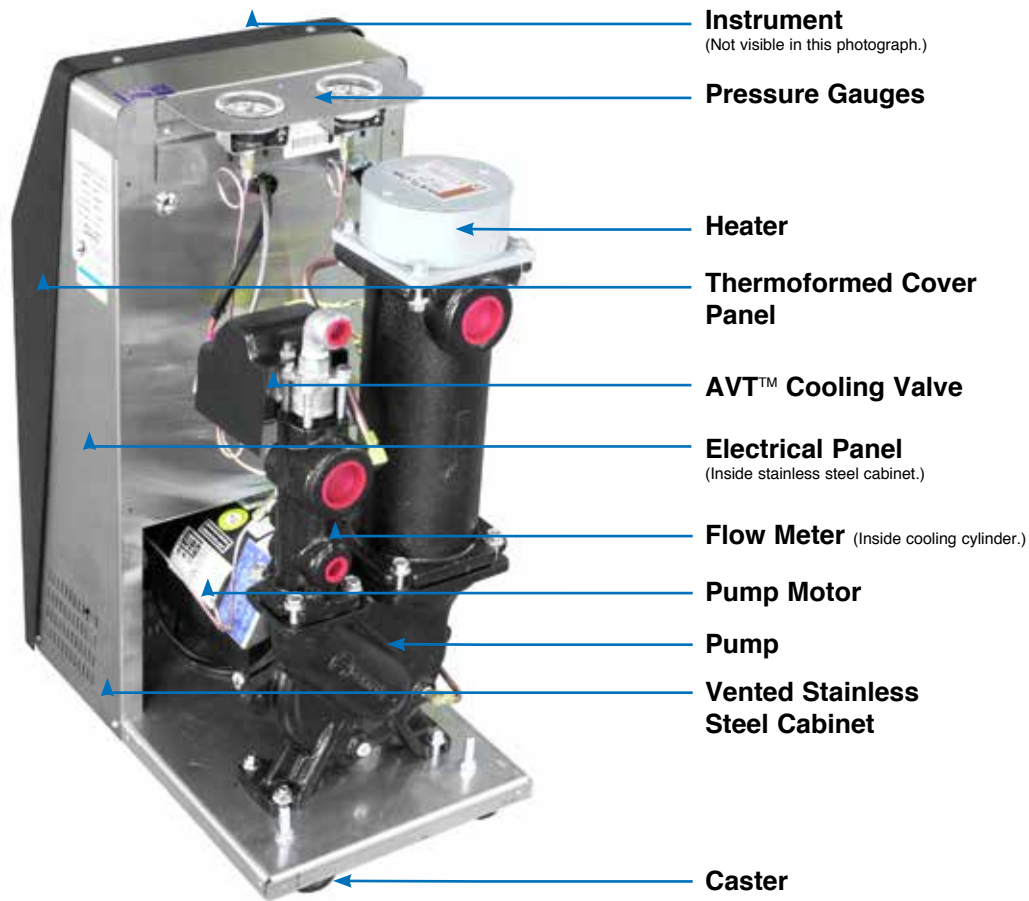



Models with 10 & 16 kW heaters and
3/4 - 3 HP pumps.
(Typical)

Models with 24 & 34 kW heaters and
5 - 7.5 HP pumps.
(Typical)



Process Connection Label
Details process connections hook-up.

Unit Data Tag
Details unit Serial Number, voltage and other important unit information.

2.0 INSTALLATION

- 2.1** GENERAL
- 2.2** TO AND FROM PROCESS CONNECTIONS
- 2.3** WATER SUPPLY CONNECTION
- 2.4** DRAIN CONNECTION
- 2.5** ELECTRICAL CONNECTION



2.1 GENERAL

- A. All process piping materials such as hose, rigid piping, valves or filters, used in process water piping circuitry must be rated for **350°F minimum temperature** and **200 PSI minimum pressure**.
- B. Be certain all process piping materials have the equivalent or larger diameter of the particular process connection.

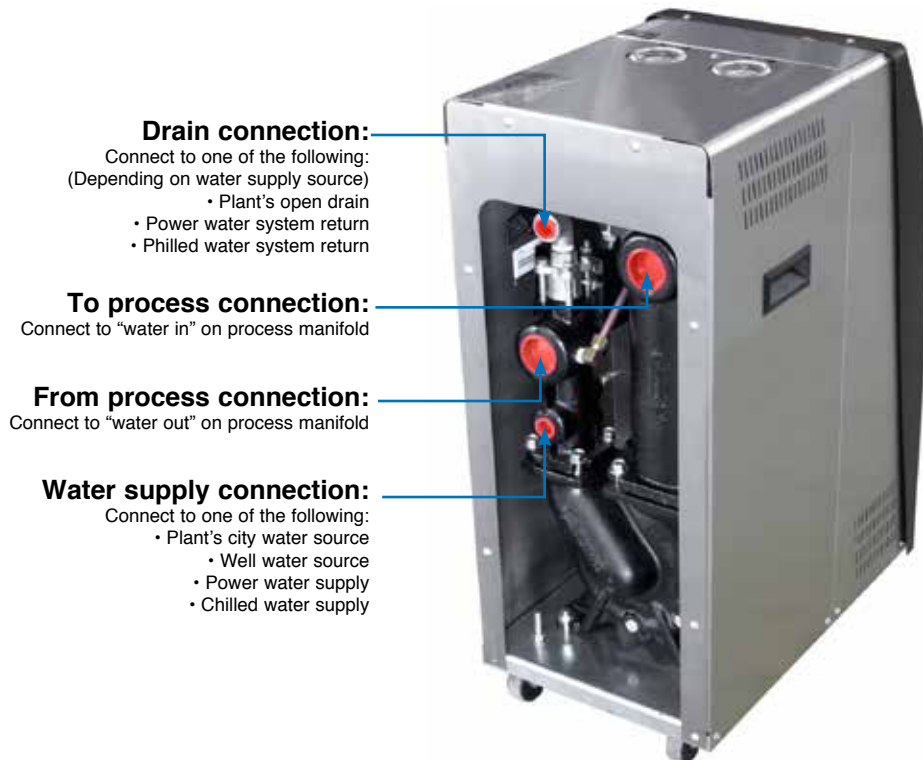

2.2 TO AND FROM PROCESS CONNECTIONS

- A. Connect the unit's *To Process* port to the *Water In* port on the process manifold.
- B. Connect the unit's *From Process* port to the *Water Out* port on the process manifold.
- C. **Please note:** Process water piping circuitry should be designed to avoid an excessive use of elbows and/or lengths of pipe or hose. If hose is the material of choice, avoid tight twists or curls and excessive lengths.
- D. Valves and filters may be installed in the process water piping circuitry to facilitate service and maintenance, provided that such devices maintain the full inside diameter of the process connection. If installed, all such devices must be open and clean during unit operation.



WARNING: Check local codes to determine proper use of back flow prevention device in water supply line.

2.3 WATER SUPPLY CONNECTION

- A. Connect the unit's *Water Supply* port to the plant's city water, well water, tower water or chilled water supply.
- B. Water supply pressure requirements vary with operating temperatures. The chart below shows the required operating water supply pressures for various operating process temperatures. The required water supply pressure retains process water in a liquid state at temperatures over 180°F. Failure to maintain the required water supply pressure will cause premature failure of and increase maintenance in susceptible areas such as the shaft seal and heater.

| OPERATING TEMPERATURE | | | | | | | |
|-----------------------|--------|--------|--------|--------|--------|--------|--------|
| 180°F | 190°F | 200°F | 210°F | 220°F | 230°F | 240°F | 250°F |
| 20 PSI | 25 PSI | 30 PSI | 35 PSI | 40 PSI | 45 PSI | 50 PSI | 55 PSI |
| WATER SUPPLY PRESSURE | | | | | | | |

- C. The factory recommended minimum operating water supply pressure requirement is identified on the unit's data tag.
- D. Static water supply pressure can be determined at the unit's location by reading the unit's 0-160 PSI pressure gauges when the unit's pump motor is **OFF**.
- E. If water supply pressure as read on the unit's pressure gauges exceeds 75 PSI, a **pressure reducing valve** must be installed in the water supply line (refer to section 7.4 of this manual for installation information). The factory recommended 'regulated pressure out' is 55 PSI.



Typical Data Plate



Typical pressure reducing valve installation (shown on S-925).

2.4 DRAIN CONNECTION:

- A. Connect the unit's **DRAIN** port to one of the following, determined by the water supply source:

1. Open drain for well or city water supply.
 2. Tower water system return for tower system water supply.
 3. Chilled water system return for chilled water system supply.
- B.** The factory recommends a minimum of 10 psi pressure differential between the water supply and drain line for proper cooling.
- C.** For most applications, the drain line should not be valved. However, for installations with a pressurized drain system, it may be necessary to install a valve in the drain line. In such cases, the installed valve must be fully opened after installation and the valve handle removed to prevent operating the unit with a closed drain valve. The valve handle can be reattached to the valve body when it is necessary to close the valve.
- D. CAUTION:** The unit must never be operated with a closed drain line valve. A closed drain line valve prevents adequate system cooling and will lead to unit overheating. Overheating of the unit may lead to unit damage and/or serious personal injury.



Typical drain valve installation
(Shown on S-925)



WARNING: Never operation the Temperature Control Unit with a closed drain.

2.5 ELECTRICAL CONNECTION

A. NEMA 1 MODELS

1. Electrical power supply requirements for Nema 1 units are identified on the equipment data tag. Verify that available voltage supply is the same as the unit's voltage requirements.

WARNING: DO NOT CONNECT THE UNIT TO A VOLTAGE SUPPLY SOURCE NOT EQUAL TO THE UNIT'S VOLTAGE REQUIREMENTS AS SPECIFIED ON THE UNIT'S DATA PLATE.

Use of incorrect voltage will void the unit's warranty and cause a significant hazard that may result in serious personal injury and/or unit damage.



WARNING: Do not connect the unit to a voltage supply not equal to the unit's voltage requirements as specified on the unit's data plate. Use of incorrect voltage will void the unit's warranty and cause a significant hazard that may result in serious personal injury and unit damage.



WARNING: Electric Shock Hazard. High Voltage is present in the electrical cabinet. Disconnect power before servicing. Follow all facility lock-out tag-out procedures.

2. For units with 10 and 16 KW heaters, a four conductor cable, 10 foot in length, has been provided for connection to an operator supplied fused disconnect.
3. For units with 24 and 34 KW heaters, the operator must provide a four conductor power cable and the fused disconnect.
4. The owner supplied fused disconnect must be sized and installed according to the unit's power supply requirements and local electrical codes.

B. NEMA 12 MODELS

1. Nema 12 units are designated by the letter "J" in the model number suffix. These units are constructed with a dust tight electrical enclosure and branch circuit fusing. Electrical power supply requirements are identified on the equipment data tag. Verify that available voltage supply is the same as the unit's voltage requirements.

WARNING: DO NOT CONNECT THE UNIT TO A VOLTAGE SUPPLY SOURCE NOT EQUAL TO THE UNIT'S VOLTAGE REQUIREMENTS AS SPECIFIED ON THE UNIT'S DATA PLATE.

Use of incorrect voltage will void the unit's warranty and cause a significant hazard that may result in damage to the unit or serious personal injury.

2. Appropriate conduit and fittings should be selected which will maintain the integrity of the cabinet.
3. Supply a power conductor sized according to the unit's power supply requirements. Connect the power conductor to the unit's power supply entry terminal block.

C. CONTROL CIRCUIT WIRING

1. The unit's supplied control circuit is 110 volt, 1 phase, 60

cycle. The control circuit is supplied by the factory installed transformer. A control circuit fuse is provided.



Control circuit transformer fuse

D. GENERAL

1. Make certain all ground connections to the unit are properly affixed. A proper connection to earth ground is required. A conduit ground is not a reliable conductor!
2. Make certain the power conductor, disconnecting means, and fusing are properly sized according to the unit's power supply requirements.
3. Make certain all electrical connections are tightly affixed. Any loose wiring connections must be tightened before engaging the power supply.
4. Make certain no moisture or standing water is present inside the electrical cabinet.



WARNING: Check that all electrical connections are tight before starting. Disconnect power before servicing. Follow all facility lock-out tag-out procedures.



Typical electrical panel with thermoformed panel removed.

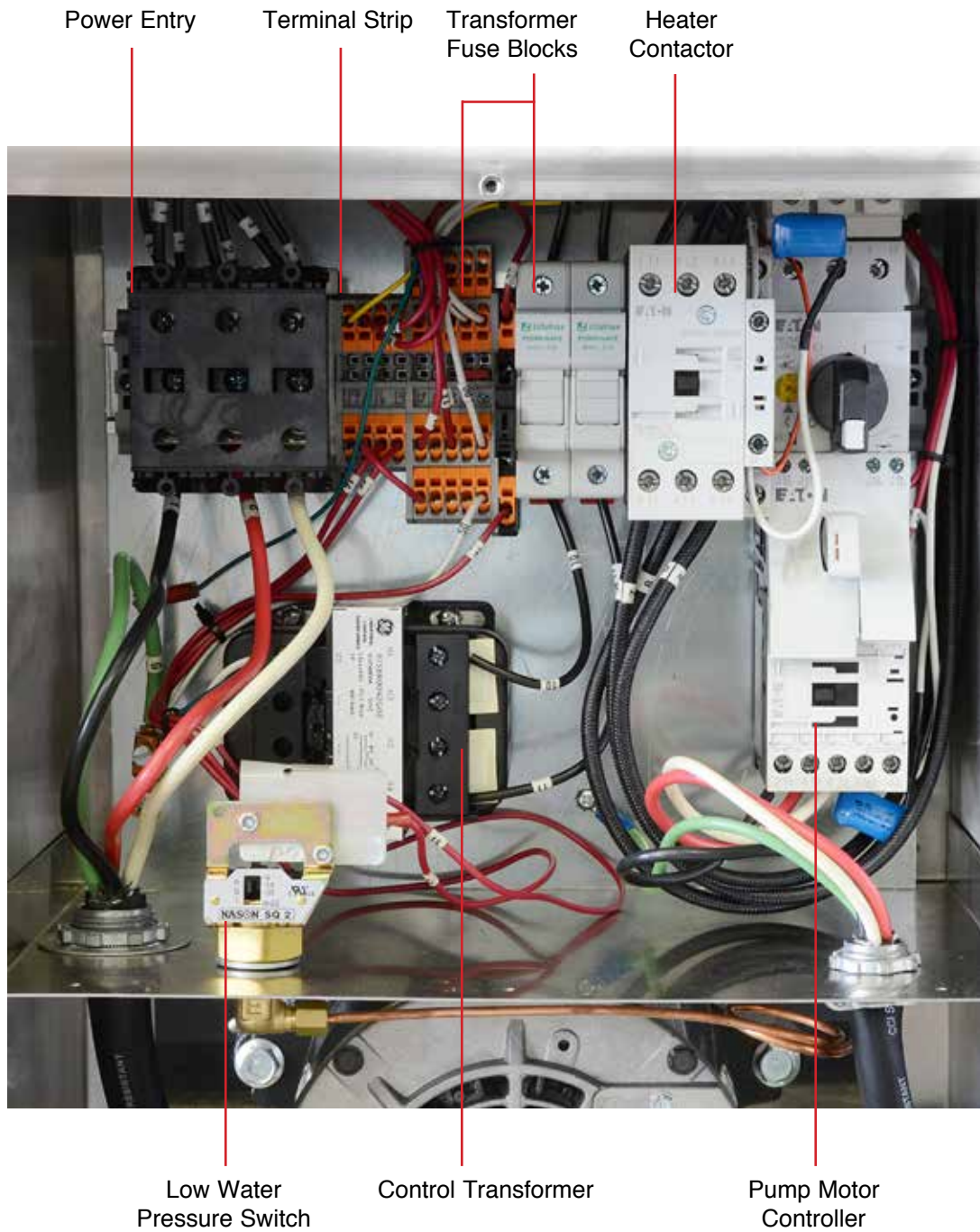

THIS PAGE INTENTIONALLY BLANK

3.0 OPERATIONS

- 3.1 GENERAL**
- 3.2 MACHINE START UP/OPERATIONS PROCEDURE**
- 3.3 'HE' INSTRUMENT OPERATION**
- 3.4 SHUT DOWN/DISCONNECT PROCEDURE**



3.1 GENERAL

- A. Failure to follow the factory required operation procedures may adversely affect the unit's ability to adequately control process temperature and may create a hazardous operating condition which may result in unit damage or serious operator injury.



WARNING: Follow all Factory operations procedures. Failure to do so may create a hazardous operating condition which may result in serious operator injury and/or unit damage.

- B. The Operations segment of this manual is outlined below:

- 3.2 Machine start-up/operations procedure** - follow this segment to start the unit after the initial installation or to restart the unit after reinstallation to the same or different process. This section includes information on system fill, electric motor phasing (pump rotation) and process flow adjustments.
- 3.3 'HE' instrument** - follow this segment to start up and operate the instrument. This section includes information on automatic and manual venting, setpoint selection and adjustment, and feature explanations.
- 3.4 Shut down procedure** - follow this segment to shut down the unit. This segment includes information on system cool down, shut down, electrical power supply precautions, and disconnection from the system.

3.2 MACHINE START UP/OPERATIONS PROCEDURE

A. SYSTEM FILL

1. Engage the water supply source by opening the water supply valve (customer installed) at the unit's location. If a valve is not installed, engage the water supply source at the plant's water supply central control point.
2. Once the water supply source is open, the unit will fill automatically. Allow a few moments for the unit to completely fill. The operator can determine the unit is properly filled when the *To Process* pressure gauge and the *From Process* pressure gauge stabilize at equal or closely similar pressure.
3. The operator must check for any water leakage in the unit's mechanical system, the process, and throughout the plant's water supply system. If a water leak is observed, the operator must disengage the water supply system, relieve

all pressure, and repair the leak. The operator must verify the leak is repaired by refilling the system as outlined in this procedure.

4. During system fill, **air** is trapped at various places in the water system. Air is purged automatically via the **AVT™** valve during initial pump start-up (outlined below). All air must be purged before the unit is engaged for process temperature control.

Entrained air in the system will adversely affect the unit's ability to control process temperature. The operator can determine all entrained air is purged when no pressure spikes are evident via the unit's pressure gauges.

5. Adequate water fill and pressure must be supplied to the unit for efficient and safe operation. To ensure sufficient water fill, an electrical panel mounted pressure switch is supplied with the unit. A capillary line feeds the pressure switch. If the water supply pressure is not adequate the unit can not be operated. This prevents operation with inadequate water fill and pressure. If the unit is operated without adequate water fill and pressure, the unit may be susceptible to overheating and could result in unit damage and/or serious injury to operating personnel.



Panel mounted pressure switch

B. ELECTRIC MOTOR PHASING (PUMP ROTATION)

1. The 'HE' instrument has electronic circuitry to determine if the unit is phased correctly.
2. Identify the *Phase* indicating light on the display. If the light is *Flashing Red*, the unit is incorrectly phased. To correct, continue with step 3. If the light is *Solid Green*, the unit is correctly phased.



3. To correct unit phase:
 - a. Disengage the electrical power supply to the unit at the unit's disconnect switch. Follow proper lockout procedures before proceeding.
 - b. Once the electrical power supply is disengaged, reverse any two power leads of the power cord at the fused disconnect terminals.
 - c. **Note: The operator must reverse the power leads at the disconnect only and *not* at the power entry terminals on the unit's electrical panel.** The unit's internal electrical system wiring is phased correctly at the factory and must not be altered in the field.



DO NOT reverse power leads at the unit's power entry to correct phase.



WARNING: To correct phase ... switch power leads at the disconnect switch only.

4. To visually verify pump rotation, press the *Start* button to engage the unit and observe the pressure gauges. The *To Process* pressure will indicate 35-50 PSI more than the *From Process* pressure. In this state, the pump rotation is correct (clockwise). If this is not evident the unit is not correctly phased and should be corrected as outlined in **step 3**.
5. An alternate method of determining pump rotation is to visually inspect the rotation of the pump motor shaft:
 - a. Supply electrical power to the unit by engaging the unit's disconnect switch. Once the correct voltage is supplied to the unit, the *Power* light on the display will illuminate.
 - b. Remove the thermoformed cover panel and open the hinged electrical cabinet panel cover. **Note that the electrical power is engaged at this point and**



WARNING: Electrical power is engaged and caution should be employed while the cabinet is open.

caution must be observed while the electrical supply is engaged and the cabinet panel is open.

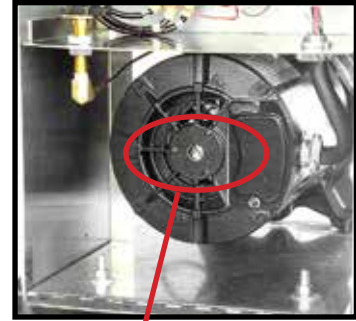

Remove shaft cover to view the motor shaft

- c. Locate the electric motor and identify the motor shaft inside the electric motor housing. The motor shaft can be seen through the vent slots in the motor housing or by removing the shaft cover.
- d. Toggle the *Start* and *Stop* push buttons. This will cycle the electrical motor “on” and then “off”.



Start and Stop Buttons on the 'HE' Control Instrument

- e. Observe the motor shaft as it slows to a stop to identify the rotation. Correct rotation is “clockwise”, when viewed from the rear of the motor. Incorrect rotation is “counter-clockwise” when viewed from the rear of the motor. If the shaft does not rotate when the *Start* switch is pressed, the operator must identify the cause as outlined in this manual’s troubleshooting and repair section.
- f. If the unit is phased correctly, continue with the start up procedure at **step C**. If the unit is phased incorrect, continue with **step 3**.

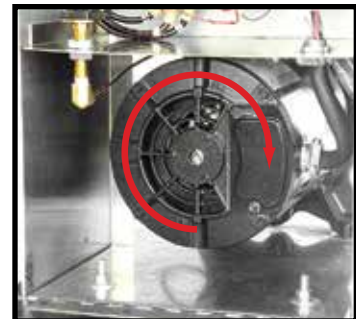

Correct rotation is clockwise when viewed from the rear of the motor.

C. PROCESS FLOW ADJUSTMENTS

1. The operator must determine and set proper water flow rate for the most efficient and trouble free operation.
 - a. Water flow rate through the process is determined by the pressure losses in the process loop. Generally, higher flow rates result in turbulent flow achieving maximum temperature control and lower maintenance.
 - b. If the flow rate exceeds the motor HP capacity, the electric motor will draw excessive amps. This is a result of the process loop's ability to flow water at a greater rate than can be provided by the pump. This will eventually result in tripping the thermal motor overload relay and the unit will shut down. The *Pump O/L* light will be illuminated on the display.

2. If a excessive flow situation is encountered and the motor overload circuit has tripped, the operator must reset the overload relay. This is done by removing the thermoformed cover panel and opening the electrical panel. Locate the reset lever on the overload relay and push the reset lever "in" until the overloads are reset, evidenced by a "clicking" sound as they reset.



Pump Motor Control

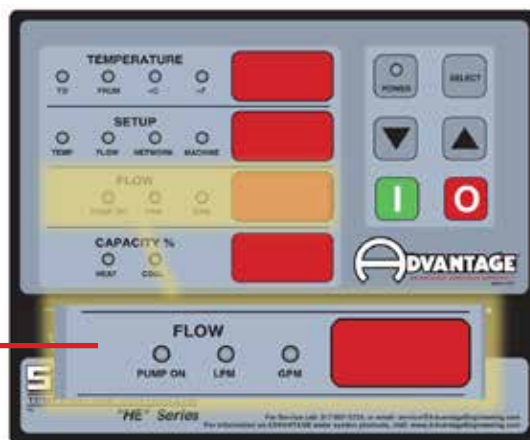

Flow display on 'HE' Control Instruments

3. The 'HE' instrument displays the process flow rate in the *Flow* display window. To adjust the process flow rate:

- a. Determine the pump's maximum flow rate. This is indicated by the last two digits listed in the model number of the unit. The model number is on the unit's data plate. For example, if the model of the unit is "SK-1035", "35" indicates the pump's maximum flow rate (35 GPM). The indicated flow rate should not be exceeded during operations. If it is, a possible overload condition may develop. Refer to section 8.2 for additional information on the unit's model number.
 - b. Start the unit and observe the indicated flow rate (see **section 3.3** of this manual for instrument operation instructions). If the indicated flow is higher than the maximum flow rate for the unit, a throttling valve must be installed in the from process water line. The throttling valve can be a gate valve or a ball valve.
 - c. With the throttling valve installed, fully close the valve and then engage the pump motor. Slowly open the throttling valve and monitor the indicated flow rate until the flow rate is below the pump's maximum flow rate. At this point, the process flow is now correctly adjusted. The valve should remain in this position during operations.
4. An alternative method to set the process flow rate is to measure the pump motor amperage and adjust the process flow rate via the motor amperage:
- a. Open electrical cabinet panel door. The panel cover is hinged and held open by a support cable. **Note that the electrical power is engaged at this point and caution must be observed while the cabinet panel is open.**
 - b. Identify the motor starter block. This block consists of the motor starter contactor and the overload relay.
 - c. Place an amp meter on a single power lead emanating from the overload relay.
 - d. Locate the motor name plate on the pump motor housing. The full load amp rating for the motor is listed on the name plate.



Typical Motor name plate with listed full load amp rating.

- e. Engage the electrical power supply and start the electrical pump motor by pressing the *Start* push button.
 - f. The amp meter will display the motor amps. Compare the actual motor amps as displayed on the amp meter to the full load amp rating as listed on the motor name plate.
 - g. If the amp draw is excessive (higher than the listed name plate amp rating), a throttling valve must be installed in the from process water line. The throttling valve can be a gate valve or a ball valve.
 - h. With the throttling valve installed, fully close the valve and then engage the pump motor. Slowly open the throttling valve and monitor the motor amps as displayed on the amp meter until the actual motor amps equal the listed full load amp rating of the motor. The process flow is now correctly adjusted. The valve should remain in the position during operations.
5. **LOW PROCESS FLOW:** The minimum recommended process flow rate is 10 GPM. The flow indicator will not accurately read below 5 GPM. Process restrictions may limit the flow to less than 10 GPM. The Manufacturer recommends the addition of bypass lines to raise the flow rate to 10 GPM. The best place to add bypass lines are on the extra ports on the molding machine manifold. If these extra ports are not available, add a tee in the *To Process* and *From Process* lines, install a bypass line between the two tees with a throttling valve. Adjust the valve for a minimum of 10 GPM. Some models offer an internal bypass and it is not necessary to add a bypass on the manifold.

3.3 'HE' INSTRUMENT OPERATION

A. START-UP

- 1. When the correct electrical power and adequate water supply pressure are supplied, the unit can be started.
- 2. When the electrical power supply is engaged, the instrument (figure 3.3A) will momentarily illuminate all indicating lights and digits on the display. After a short delay, the controller software version number will be displayed in the *Temperature* window. At this time, the operator can verify that all lights and digits are functioning. If an indicating light or digit does not illuminate, the instrument must be removed and sent to the factory for repair.



'HE' display

3. With electrical power supplied to the unit, the *Power* light will illuminate. Before the *Start* push button is pressed, the display will remain dark expect for the *Probe*, *Valve* and *Phase* lights, which will be *Solid Green* if their conditions are 'OK'. This is the normal "stop" state of the instrument. If the *Probe*, *Valve* and *Phase* lights are *Flashing Red*, the operator must determine the reason and correct:
 - a. **Probe Error:** A possible cause of a probe error is the probe service connection is wet. Locate the 2 pin (white plug) service connection, open and dry with compressed air. If this does not remove the error indication, inspect the probe wiring, which could be incorrect or damaged. Probe connections are at the instrument panel. Correct wiring is (from top to bottom) 'white' - 'black' - 'white' - 'black' - 'red' - 'red'. If probe connections are correct and the error condition remains, the probe may be faulty and should be replaced.
 - b. **Valve Error:** Indicates the instrument cannot verify valve position. Refer to section 5.3 for service.
 - c. **Phase Error:** Follow the procedure outlined in section 3.2. paragraph B 'Electric Motor Phasing' to correct a phase error. If a phase error can not be cleared even though the pump motor is rotating correctly, the three phase monitor is defective and should be replaced. Disconnect the unit until a replacement is obtained.

4. After a *Flashing Red* fault indication is diagnosed and repaired, the indication will turn *Solid Red*. The operator can clear the fault indication by pressing the *Start* push button.
5. When the *Start* push button is pressed, the instrument will check the status of the water supply pressure switch (*Water Press* light), the motor overload switch (*Pump OL* light) and the high temperature safety switch (*Hi Temp* light) for acceptable operating conditions. If these are found to be 'ok', the lights will be *Solid Green* and the unit will begin operation. If a system is not 'ok', the light will *Flash Red* and the unit will not start.
6. Conditions that will prevent the unit from starting process temperature control operations are:
 - a. **Water supply pressure inadequate.** The *Water Press* indicator light is *Flashing Red*. The unit can not operate without adequate water supply pressure. Sufficient water supply pressure must be present to close the water pressure switch.
 - b. **Motor overload switch opened.** The *Pump OL* indicator light is *Flashing Red*. The pump motor is protected from excessive flow by a set of thermal overload relays which open (trip) with excessive amperage. If the overload relay is open, the overload relay must be reset before operations can continue. An excessive flow condition must be corrected immediately.
 - c. **High temperature limit switch open.** The *Hi Temp* indicator light is *Flashing Red*. The unit is prevented from operating with process temperatures exceeding 256°F by the high temperature limit switch. This switch is installed in the *To Process* temperature sensor. If a high temperature condition exists, the unit must first cool down before the high temperature limit switch can automatically reset.

B. INSTRUMENT OPERATION

1. The operator must verify the *Probe*, *Valve* and *Phase* lights are *Solid Green*. If these lights are *Flashing Red*, the operator must determine why and correct.
2. Process temperature control operation is started by pressing the *Start* push button.
 - a. The instrument will display the previously selected setpoint temperature in the *Set Up* display window,

as indicated by the *Temp* light. The selected setpoint temperature is displayed continuously unless the operator selects *Flow*, *Network* or *Machine* setup displays. After 10 seconds of inactivity in these setup areas, the display will automatically revert to the *Temp* display.

- b. The instrument will also display the *To Process* temperature as read by the temperature probe which is mounted at the top of the heater/discharge tank. All control functions are based on this temperature. The operator can select between the *To Process* or *From Process* temperature for display in the *Temperature* window. The display reverts to the *To Process* temperature after 10 seconds of inactivity if the *From Process* temperature was displayed. The display can be programmed for Fahrenheit or Celsius as indicated by the ° F or the ° C lights.
- 3. If the indicated *To Process* temperature is less than 100°F, the instrument will automatically open the AVT™ modulating cooling valve for 30 seconds to purge entrained air from the system. This is effective in most process situations. Air purging is indicated by a flashing *Cool* light. Note that the *Capacity %* display will read "100". If the automatic purge cycle does not result in the venting of all entrained air to the drain (evidenced by a "rattling" sound in the unit and fluctuating pressure gauges), the operator must manually vent the process. Forced venting is done by holding the *Start* or *Stop* push button for more than 5 seconds.
- 4. If the *To Process* temperature exceeds 100°F, the automatic air purge cycle is bypassed.
- 5. The operating setpoint temperature is selected by using the *Select* push button to index to the *Temp* indicating light. Depress the *Up Arrow* push button or *Down Arrow* push button until the preferred setpoint temperature is indicated in the *Setup Display* window. Setpoint temperatures can be adjusted anytime during the process temperature control cycle. **Note:** The operator may directly adjust the setpoint without using the *Select push buttons* when the *To Process* temperature light is on.
- 6. The *Temp Dev* (temperature deviation) light will remain off until the setpoint temperature is achieved and maintained.
- 7. Press the *Stop* key to halt unit operations.

C. **INSTRUMENT CONTROLS**

- 1. **START:** starts unit operations by engaging electrical supply



to the pump, heater and AVT™ modulating cooling valve. Depress and hold the *Start* push button to initiate a forced



vent of the unit by opening the AVT™ modulating cooling valve to quickly cool the unit on demand or purge entrained air.

2. **STOP:** Stops unit operations by disengaging electrical supply to the pump, heater and AVT™ modulating cooling valve. Depress and hold the *Stop* push button to initiate a forced vent of the unit by opening the AVT™ modulating cooling valve to quickly cool the unit on demand or purge entrained air.
3. **SELECT:** Scrolls through available setup parameters. Parameters appear in the *Temperature* window and the value will appear in the *Setup* window.
4. **UP ARROW:** Depress and hold to increase the selected parameter. If this push button is pressed momentarily the value is incremented by one unit. If the push button is held down for more than one second, the value will increase slowly at first and then faster after about two seconds.
5. **DOWN ARROW:** Depress and hold to decrease the selected parameter. If this push button is pressed momentarily the value is incremented by one unit. If the push button is held down for more than one second, the value will increase slowly at first and then faster after about two seconds.

D. TEMPERATURE DISPLAY

1. **TO:** Illuminates when the *To Process* water temperature is displayed and is the default setting of the *Temperature* display window.



2. **FROM:** Illuminates when the *From Process* water temperature is selected. **Note:** The instrument will revert back to the *To* temperature display after 10 seconds if the *From* process temperature was selected and displayed and the instrument was left in that state. Use the *Select* key to scroll to the *From* display. The *From Process* temperature will be displayed in the *Temperature* window.
3. **°C:** illuminates when the ° C (Celsius) temperature display parameter is selected.
4. **°F:** illuminates when the ° F (Fahrenheit) temperature display parameter is selected and is the default setting.

E. SETUP DISPLAY

1. *Temp* : Illuminates when the setpoint temperature is displayed and is the default display setting of the *Setup* display window.
2. The setpoint temperature can be adjusted by:



- a. Use the *Select* key to index to the *SP* display in the *Temperature* window (the *Temp* light is illuminated). The setpoint temperature value is displayed in the *Setup* window. Use the *Up Arrow* or *Down Arrow* push buttons to select the value.
 - b. When the instrument is in the default state (*To Process* temperature display), the operator may adjust the setpoint temperature with the *Up Arrow* or *Down Arrow* push buttons without using the select key if the instrument is in any other state (i.e. the *Network* state). Otherwise, the operator must use the *Select* key to index to the *Temp* indication to adjust the setpoint.
3. The *HI* and *LOW* temperature alarm values are programmed by:
 - a. Use the *Select* key to index to the *HI* display in the *Temperature* window (the *Temp* light is illuminated). The high temperature alarm value is displayed in the *Setup* window. Use the *Up Arrow* or *Down Arrow* push buttons to select the value (1-30 units selectable).
 - b. Use the *Select* key to index to the *LO* display in the *Temperature* window (the *Temp* light is illuminated). The *Low Temperature Alarm* value is displayed in the *Setup* window. Use the *Up Arrow* or *Down Arrow* push buttons to select the value (1-30 units selectable).
4. **FLOW:** Illuminates when the *Flow Parameter* is selected. This is an alarm trigger. Once the flow setting is programmed, an alarm signal is generated if the flow decreases to the programmed value. 30 seconds of flow stability must be maintained before the controller will arm the flow alarm. Use the *Select* key to index to the *LoF* display in the *Temperature* window (the *Flow* light is illuminated). The value is displayed in the *Setup* window. Use the *Up Arrow* or *Down Arrow* push buttons to select the value (0-999 units selectable).
5. **NETWORK:** Illuminates when the *Communications Parameters* are selected. Available are *Communications Address*, *Baud Rate* and *Protocol*.
 - a. **Communication Address:** This is the number assigned to the unit in a network. Use *Select* to scroll to the *Adr* display in the *Temperature* window (the *Network* light is illuminated). The value is displayed in the *Setup* window. Use the *Up Arrow* or

Down Arrow push buttons to select the value (1-99 units selectable).

- b. **Baud rate:** This is the data transfer rate of between the unit and the host computer. Use *Select* to scroll to the *rAt* display in the *Temperature* window (the *Network* light is illuminated). The value is displayed in the *Setup* window. Use the *Up Arrow* or *Down Arrow* push buttons to select the value (1200-2400-4800-9600 units selectable).
- c. **Protocol:** This is the data format for communication between the unit and the host computer. Use *Select* to scroll to the *Pro* display in the *Temperature* window (the *Network* light is illuminated). The value is displayed in the *Setup* window. Use the *Up Arrow* or *Down Arrow* push buttons to select the value. Available values are SPI or CAC. *SPI* is the standard Society of Plastics Industry, Inc. protocol. *CAC* is the CAMAC protocol used on older CMI machines.

6. **MACHINE:** Illuminates when the *Machine Parameters* are selected. Available are: *Fahrenheit* with GPM flow display, or *Celsius* display with LPM flow display.

- a. Use the *Select* key to index to the *Unt* display in the *Temperature* window (the *Machine* light is illuminated). The value is displayed in the *Setup* window. Use the *Up Arrow* or *Down Arrow* push buttons to select the value (*F* or *C* are selectable).

F. FLOW DISPLAY

- 1. The *Flow* display shows information concerning the pump generated flow. The flow measuring mechanism is installed in the cooling cylinder.



- a. **PUMP ON:** Illuminates when the pump is operating.
- b. **LPM - Liters per minute:** Illuminates when the “C” machine parameter is selected.
- c. **GPM - Gallons per minute:** Illuminates when the “F” machine parameter is selected.

G. CAPACITY % DISPLAY

- 1. The *Capacity %* display shows information concerning the

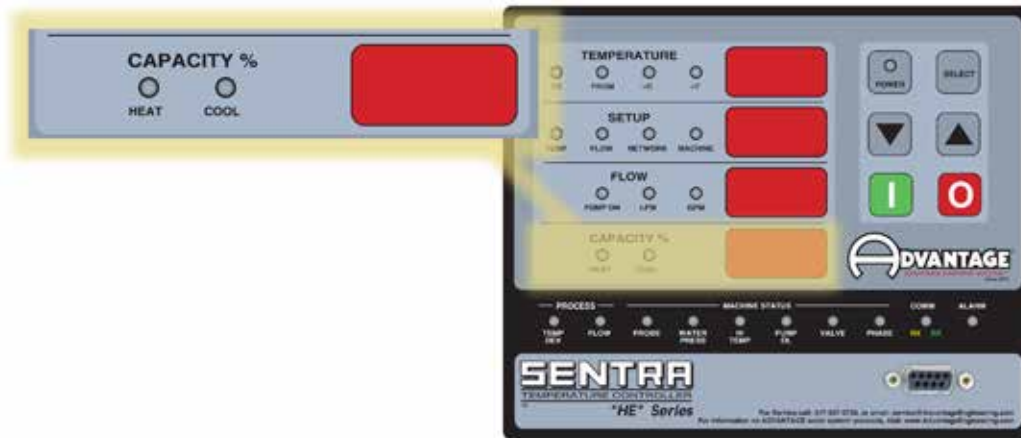

“in use” heating and cooling capacity of the unit. *Heat* and *Cool* indicating lights determine which capacity percent is displayed.

- a. **HEAT:** When illuminated, the unit is in the heating mode (heater on). The number displayed in the *Capacity %* window is percent of “on-time” use of the heater.
- b. **COOL:** When illuminated, the unit is in the cooling mode (heater off) and the AVT™ valve is opening. The number displayed in the *Capacity %* window is “how much” the AVT™ valve is open.
- c. **DEAD BAND:** When illuminated, the unit is not in the *Heat* and *Cool* mode.

H. PROCESS LIGHT DISPLAY

- 1. The process display is an alarm indication for *Temperature Deviation* and *Flow*.
 - a. **TEMP DEV:** this light will be *Solid Green* when the process temperature is within the programmed setting. The light will be *Solid Yellow* if the process

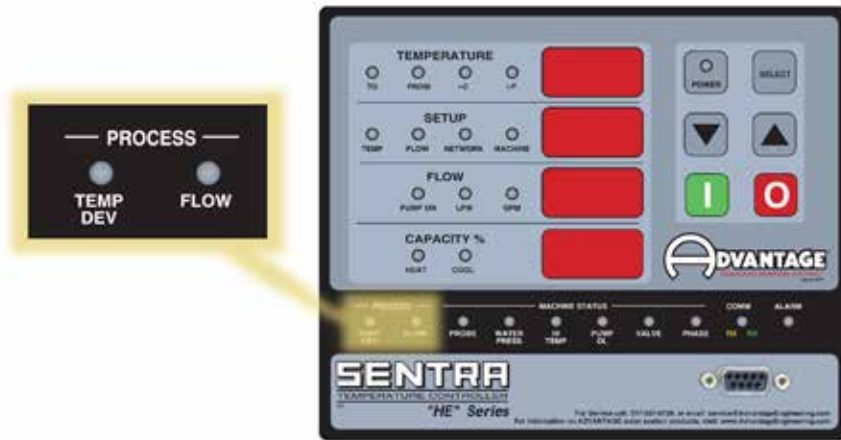

temperature deviates outside the programmed setting. If the temperature remains out of band for 90 seconds or more, the light will *Flash Red* and activate the alarm.

- b. **FLOW:** this light will be *Solid Green* when the process flow is within the programmed setting. The light will *Flash Red* if the flow deviates beyond the programmed setting. The light will be *Solid Red* if the flow once had deviated but is now within the programmed settings.

I. MACHINE STATUS



1. Machine status lights indicate the operating status of several machine components. For each component:

A *Solid Green* light indicates an acceptable run condition

A *Flashing Red* light indicates that the component is currently in an unacceptable run condition.

A *Solid Red* light indicates the component had once been in an unacceptable run condition but is now in an acceptable run condition.

A *Flashing Red* light can be cleared to a *Solid Green* light by pressing the *Start* key.

- a. **PROBE:** Indicates the status of the *To Process* and *From Process* sensor probes.
- b. **WATER PRESS:** Indicates the status of the water supply pressure switch.
- c. **HI TEMP :** Indicates the status of the high temperature limit switch.
- d. **PUMP OL:** Indicates the status of the pump motor overload relay. See section 3.2 paragraph C.2 for more information on the motor overload relay.
- e. **VALVE:** Indicates the status of the AVT™ modulating cooling valve.
- f. **PHASE:** Indicates the status of the electrical phasing of the unit. See section 3.2 paragraph B for more information.

J. COMMUNICATION DISPLAY



- 1. This display indicates the kind of exchange between the host computer and the unit. A single light is used:
 - a. **GREEN FLASH:** Indicates the unit is sending information to the host computer.
 - b. **YELLOW FLASH:** Indicates the host computer is sending information to the unit.

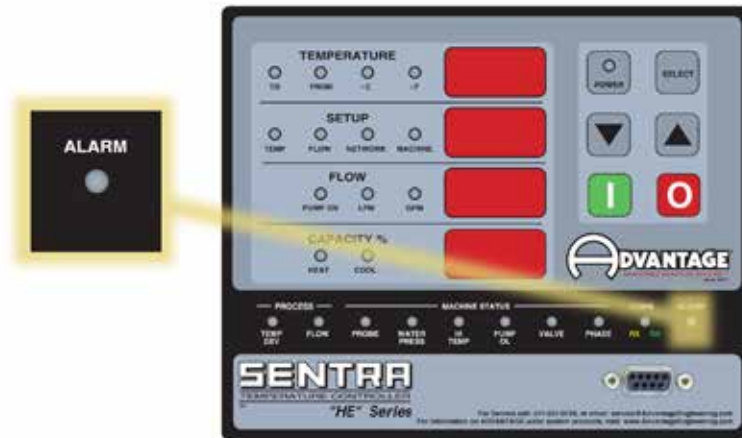

K. ALARM DISPLAY

1. **ALARM:** When *Solid Red*, an unacceptable condition has developed. A 115 volt alarm output is provided for external (factory or customer installed) alarm beacon or buzzer. The alarm can be silenced by pressing the *Start* push button.



WARNING: Follow all shut down procedures outlined in this manual.



WARNING: Relieve static pressure before disconnection process lines.

3.4 SHUT DOWN/DISCONNECT SEQUENCE

A. PRECAUTIONS/WARNINGS

1. The operator must precisely follow all shut down procedures outlined in this manual. If the operator fails to do so, an unsafe condition can develop resulting in damage to the unit or injury and/or death to operating personnel.
2. When disconnecting the unit from the process system, the operator must determine



Typical pressure relief valve

the unit's process temperature is at ambient or below 85°F and all system pressure is relieved and the unit's pressure gauges read "0". Injury or death to operating personnel and damage to the unit could result if a hot and pressurized unit is disconnected from the system.

B. UNIT SHUT DOWN (without system disconnect)

1. Adjust the setpoint temperature to 32°F. The instrument will disengage the heater contactor (if engaged) and fully open the AVT™ valve. Operate the unit until process temperature as indicated on the *Temperature* display is at the ambient water supply temperature or below 85°F.
2. Stop unit operations by pressing the *Stop* push button.
3. Disengage the water supply to the unit by closing the water supply valve (if installed) or by turning off the water supply source at the central control point. If any residual pressure is evident open the pressure relief valve (figure 3.4A) to dissipate.
4. Disengage the power at the fused disconnect. Determine the *Power* light on the display is **OFF**.
5. Before disconnecting and removing the process circuitry, be certain all system pressure is vented and the pressure gauges read "0". When the process circuitry is disconnected and removed from the unit, a small amount of water will be discharged from the unit. Please note that this water should not be warm or pressurized if all shut down and disconnecting procedures were followed. Remaining process water can be discharged by removing the pump casing drain plug.

4.0 TROUBLESHOOTING

- 4.1** UNIT WILL NOT START (POWER LIGHT IS NOT ILLUMINATED)
- 4.2** UNIT WILL NOT START (POWER LIGHT IS ILLUMINATED)
- 4.3** UNIT STOPS
- 4.4** UNIT OVERHEATS
- 4.5** UNIT UNDERHEATS
- 4.6** PRESSURE RELIEF VALVE LEAKS
- 4.7** COOLING VALVE FAULT "ULU"





WARNING: Before troubleshooting or servicing this unit, follow all company lock-out tag-out procedures.

4.1 UNIT WILL NOT START (POWER LIGHT IS NOT ILLUMINATED)

- A. One or more fuses at the main disconnect device are open (blown). Determine continuity at each fuse. If continuity is not determined, replace the fuse. Then determine cause of blown fuse.
- B. Control circuit transformer fuse is open (blown). Determine continuity at the control circuit transformer fuse. If continuity is not determined, replace the fuse.

4.2 UNIT WILL NOT START (POWER LIGHT IS ILLUMINATED)

- A. **Power supply is ON.** The operator can determine that electrical power supply to the unit is "on" by an illuminated *Power* light on the display. Even with the main power supply on, the unit is prevented from operating by one of the following conditions:
 - 1. **WATER PRESS light 'flashing red' - water supply pressure inadequate** (pressure switch is open). The unit is prevented from operation without adequate water supply pressure by the electrical panel mounted pressure switch. Sufficient water supply pressure must be present to close the switch.
 - 2. **PUMP O/L light 'flashing red' - motor overload switch opened.** The electric motor is protected from overload conditions by a set of thermal overload relays. These relays will open (trip). If the overload relay is open, it must be reset before operation can continue. An excessive flow condition must be isolated and corrected immediately.
 - 3. **HI TEMP light 'flashing red' - high temperature limit switch open.** The unit is prevented from operations at temperatures exceeding 256°F by a "high temperature limit switch". This switch is installed in the *To Process* temperature sensor. If this switch is open (due to a high temperature condition), the unit cannot be started and must "cool down" before the "high temperature limit switch" will automatically reset.
 - 4. **VALVE light 'flashing red'** - indicates the valve is not able to find the "home position". At start up, the instrument turns the valve until it finds the 'home position'. Once found, it then knows how far to step the valve open and closed. 'Home' is established by two screws 180° apart on the valve coupling. When the screw head raises the wheel

on the home microswitch, it closes the circuit to establish home position. If the switch is not adjusted properly or is defective home base cannot be established and a fault will be displayed. To resolve this fault see section 5.3 for AVT™ valve service.

4.3 UNIT STOPS

- A. The operator should determine the main power supply to the unit is **ON** by an illuminated *Power* light on the display. With the main power supply “on”, the unit will be prevented from starting by the following conditions:
1. **WATER PRESS light ‘flashing red’ - water supply pressure inadequate** (pressure switch is open). The unit is prevented from operation without adequate water supply pressure by the electrical panel mounted pressure switch. Sufficient water supply pressure must be present to close the switch.
 2. **PUMP O/L light ‘flashing red’ - motor overload switch opened.** The electric motor is protected from overload conditions by a set of thermal overload relays. These relays will open (trip). If the overload relay is open, it must be reset before operation can continue. An excessive flow condition must be isolated and corrected immediately.
 3. **HI TEMP light ‘flashing red’ - high temperature limit switch open.** The unit is prevented from operations at temperatures exceeding 256°F by a “high temperature limit switch”. This switch is installed in the *To Process* temperature sensor. If this switch is open (due to a high temperature condition), the unit cannot be started and must “cool down” before the “high temperature limit switch” will automatically reset.
- B. The operator should check the *Power* light on the display. The operator should check the following conditions:
1. One or more fuses at the main disconnect device are open (blown). Determine continuity at each fuse. If continuity is not determined, replace the fuse. Then determine cause of blown fuse.
 2. Control circuit transformer fuse is open (blown). Determine continuity at the control circuit transformer fuse. If continuity is not determined, replace the fuse.

4.4 UNIT OVERHEATS

- A. This is evidenced by *To Process* temperatures consistently above the selected setpoint temperature. Overheating is also evidenced

by a *To Process* temperature that continues to escalate above the setpoint temperature with no apparent cooling action, even though the *Cool* light is on. Extreme overheating is evidenced by *To Process* temperatures over 256°F. The operator should check for the following conditions:

1. **Inadequate water supply pressure.** The unit must be supplied with adequate water flow to provide cooling when required. The minimum pressure differential between the water supply and drain to achieve full cooling capacity is 10 PSI. The minimum water supply pressure is 20 PSI. A drop in water supply pressure operation will cause the pump to stop and a safety fault to be displayed.
2. **AVT™ valve defective.** The instrument opens and closes the AVT™ cooling valve in incremental steps between 0 to 100% as prescribed by the current process load. A continual discharge stream of process water to drain is present under most operating conditions (except at full heat-up). This allows the unit to maintain virtual straight-line control of process water temperature. If the AVT™ valve becomes clogged with process water debris or scaled with mineral deposits, its operation is hindered or fully prevented and adequate process water discharge to drain is prevented. The operator must remove the AVT™ valve and remove any loose debris. Massive debris or scale deposits may necessitate replacement of the AVT™ valve. The procedure for servicing the AVT™ valve is outlined in Section 5.3 of this manual.
3. **Drain line obstruction.** The operator must determine if the drain line is obstructed by the following conditions. Section 2.4 outlines the parameters of correct drain line installation.
 - a. **Closed drain line valve.** An installed but partially or fully closed valve in the drain line prevents full discharge to drain and contributes to an overheating condition. The operator should determine the drain line is open.
 - b. **High drain back pressure.** Pressurized plant drain lines will prevent flow to drain if the differential between the water supply pressure and the drain line pressure is inadequate. The factory recommended minimum differential is 20 psi. If the differential is less than the factory recommendation, plant service personnel should take measures to reduce drain line pressure.
4. **Instrument defective.** The instrument is designed and manufactured exclusively by Advantage. The instrument is life-tested and found to be field reliable. However, in the

case where the instrument is determined to be defective, the operator must remove the assembly according to instructions outlined in section 5.8 and return the assembly to the factory. The instrument is not a field serviceable component.

4.5 UNIT UNDERHEATS

- A. This is evidence by operations with *To Process* temperatures consistently below the selected setpoint temperature.
1. **Process water leakage.** When the instrument engages the heater to elevate process temperature, the input of heat into the process can be offset by a defective AVT™ valve. If the AVT™ valve is defective, it may pass a larger than required stream to drain, thus providing unwanted cooling. A defective AVT™ valve should be repaired immediately.
 2. **Heater element failure.** A failed heater element will not input adequate heat into the process to elevate the process water temperature. The operator must check the amps at the heater contactor with the contactor energized. Zero amps at the contactor indicate a failed heater or burnt wire connections. The operator should remove the failed heater and replace with a new heater according to the procedure outlined in section 5.2.
 3. **Unit capacity too low.** This occurs when the process requires more heat than the unit is capable of producing. The only option in such cases is to install a unit with an adequate heater KW rating for the load.
 4. **Instrument defective.** The instrument is designed and manufactured exclusively by Advantage. The instrument is life-tested and found to be field reliable. However, in the case where the instrument is determined to be defective, the operator must remove the assembly according to instructions outlined in section 5.8 and return the assembly to the factory. The instrument is not a field serviceable component.

4.6 PRESSURE RELIEF VALVE LEAKS

- A. The unit has a 150 psi pressure relief valve mounted in the cooling cylinder. If the valve is found to be leaking, the operator should check the following:
1. **Water supply pressure exceeds 75 psi.** The unit is designed to operate with water supply **NOT** exceeding 75 psi. See section 2.3 paragraph B for specific water supply pressure requirements at corresponding setpoint temperatures. If the plant water supply pressure exceeds

75 psi, the pressure relief valve may leak. Static water supply pressure can be determined at the unit's location by reading the unit's 0-160 PSI pressure gauges when the unit's motor pump is **OFF**. If the water supply pressure at the unit's location exceeds 75 PSI, a **pressure reducing valve** must be installed in the water supply line. The factory recommended 'regulated pressure out' is 55 PSI. Refer to section 7.4 for regulator installation drawing.

2. **Back flow prevention device in water supply line.** If a back flow prevention device (check valve, pressure regulator, closed valve) is installed in the water supply line, increased pressures from thermal expansion are unable to move into the water supply line. This will increase the unit's internal pressure causing the pressure relief valve to leak. Refer to section 7.4 for regulator installation drawing.
3. **Valve contamination.** The pressure relief valve may become contaminated with water debris causing the valve not to close properly. If this is the case, flushing the valve for a moment will cleanse the seat and allow it to work properly. If flushing the valve does not remedy the leaking, the valve must be replaced.
4. **Extreme internal system pressure.** If the internal pressure in the **Sentra** unit is elevated, the pressure relief valve will leak as a safety measure to dissipate excessive pressure. If this is the case, the operator must determine why the system internal pressure is excessive and correct the condition.

4.7 COOLING VALVE FAULT

- A. **AVT™ FAULT.** When power is applied, the AVT™ valve begins a 'homing process'. The valve is turned forward and backward across a limit switch to establish the valve position. If valve position cannot be established, a fault will be displayed in the *Temperature* display window as *ULU*. Refer to section 5.3 for AVT™ service and repair instructions.

5.0 SERVICE/MAINTENANCE

- 5.1** PUMP SEAL REPLACEMENT
- 5.2** HEATING CYLINDER SERVICE
- 5.3** AVT™ COOLING VALVE SERVICE
- 5.4** PROBE CALIBRATION
- 5.5** VOLTAGE CHANGEOVER
- 5.6** SENSOR PROBE SERVICE
- 5.7** PRESSURE SWITCH SERVICE
- 5.8** INSTRUMENT SERVICE
- 5.9** ELECTRONIC INSTRUMENT REPAIR POLICY & PROCEDURE
- 5.10** FLOW METER SERVICE



5.1 PUMP SEAL REPLACEMENT

A. The pump seal is a carbon/ceramic shaft seal assembly including a stationary member, rotating member and tension spring (figure 5.1A).

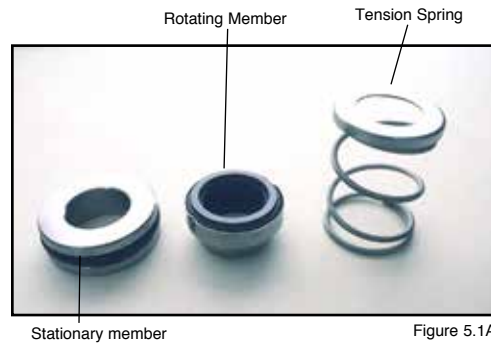

B. The life cycle of the pump seal is determined by hours of use, operating temperature and water quality. Poor water quality is the primary reason for premature pump seal failure.

D. The operator should follow this procedure to replace the pump seal:

1. Disengage process operations and relieve all system pressure.
2. Disengage main power supply. Verify the *Power* light on the display is "off".
3. Remove the lift-off access panel and set aside.
4. Remove the thermoformed panel. It is attached to the stainless steel cabinet by 4 small screws (figure 5.1B).
5. Drain machine by removing the pump casing drain plug.
6. Remove the three motor wire leads from the motor wiring terminals. The operator should "map" the wire terminal locations to ensure correct rewiring. The power cord should be removed from the motor housing (figure 5.1C).
7. Locate and remove the 4 pump casing bolts. These bolts secure the motor and motor adapter to the pump casing (figure 5.1D).



Thermoformed panel removed and electrical cabinet open.

Figure 5.1B

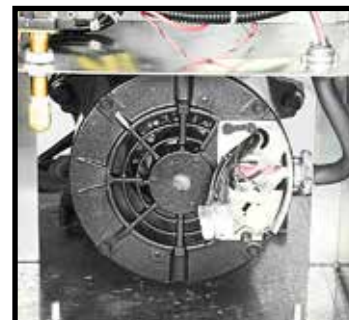

Motor leads

Figure 5.1C

8. Separate the motor and adapter from the pump casing to expose the pump impeller (figure 5.1E). Remove the motor and adapter from the unit and place on a workbench to continue the procedure.

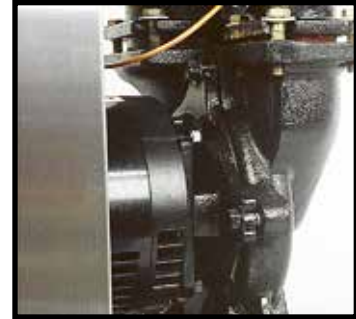

Pump casing bolts

Figure 5.1D

9. Locate and remove the dust cap from the motor to expose slotted motor shaft. The motor shaft is free to rotate, but must be secured to remove the impeller. To secure the motor shaft, insert a flat bladed screw driver in slot to hold the shaft stationary (figure 5.1F).

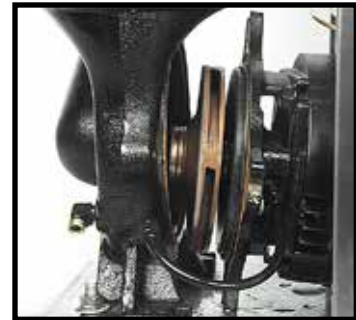

Impeller

Figure 5.1E

10. Locate and remove impeller locking screw (figure 5.1G). Using a socket and ratchet, the impeller retaining screw can be removed. Once removed, the impeller can be "unthreaded" from the motor shaft to expose the pump seal assembly.



Motor shaft

Figure 5.1F

11. Remove all seal parts (figure 5.1H). Note seal component arrangement to facilitate reassembly.

12. Clean the motor shaft and lubricate with a mild soap solution. **Note: Oil must never be used as a lubricant as it will damage the rubber parts of the seal assembly.**



Removing impeller locking screw with ratchet

Figure 5.1G

13. Install new stationary seal member in pump casing cavity (figure 5.1I). Be certain the stationary seal member is fully squared and seated in cavity.

14. Slide the rotating member

onto the lubricated pump shaft (figure 5.1J). Be certain not to damage or tear the rubber bellows assembly.

15. Place the spring onto the rotating member.
16. Align the tension spring and rotating member before reinstalling the impeller (figure 5.1K). Be certain the spring and rotating member are aligned before the impeller is fully tightened and the impeller retaining screw is reinstalled.
17. Clean the pump casing, cavities, impeller and O-ring before reassembly.
18. Mate the motor and adapter to the pump casing. Reinstall the 4 pump casing bolts.
19. Reconnect the motor power cord and leads.
20. Replace the thermoformed front panel and the lift-off cover.

- E.** When this procedure is complete, the operator may restart the unit. In many cases, a new pump seal will experience a small amount of leakage for a short time. This is normal. After a few moments, the new seal will take seat and the leak will stop.



Seal components

Figure 5.1H



Stationary member

Figure 5.1I



Rotating member

Figure 5.1J



Aligning impeller and spring

Figure 5.1K

5.2 HEATING CYLINDER REPLACEMENT

A. The heater is a flange mounted assembly and inserted into the cast cylinder tank and secured by 4 bolts (figure 5.2A).



Heater

Figure 5.2A

B. The operator can determine if the heater requires replacement when the heater draws "0" amps or when a continuity check of each heater element is negative.

C. Generally, heaters fail due to low water flow, low water pressure, air in the system, or defective heating elements.

D. The operator should follow this procedure to replace the heater:

1. Disengage operations and be certain all system pressure is relieved and the unit's pressure gauges read "0".

2. Disengage main power supply. Verify the *Power* light on the display is "off".

3. Remove the lift-off access panel and set aside

4. Drain machine. The machine can be drained by removing the pump casing drain plug.

5. Remove heater's junction box cover to located wiring connections. The operator should "map" the wiring connections to ensure correct reinstallation (figure 5.2B).



Heater junction wires

Figure 5.2B

6. Disconnect the three power leads from the heater terminals. Remove the power cord from the junction box.

7. Remove the 4 heater mounting bolts (figure 5.2C).



Heater mounting bolt

Figure 5.2C

8. Remove heater (figure 5.2D).

9. Before the new heater is installed, the mating surface of the cast tank should be cleaned. Once cleaned, place the new heater gasket onto the tank mating surface. Coat the mating surface with a high temperature gasket sealant.

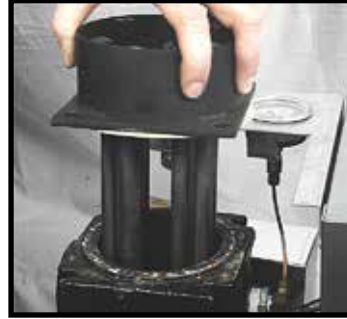

Remove heater

Figure 5.2D

10. Set new heater into tank. Aligning the bolt pattern of the heater and tank flanges.
11. Replace the 4 heater mounting bolts. Alternate to the opposite bolt while tightening.
12. Reconnect the power cable to the heater terminals. Be certain to tighten the power cord junction box connector. Replace the junction box cover and the lift-off cover panel.

- D. When complete, restart the unit.

5.3 AVT™ COOLING VALVE SERVICE

- A. The AVT™ cooling valve is a two component assembly, consisting of the motor/gearbox and valve assembly, mated with a machined aluminum coupling. The AVT™ valve assembly is sheltered by an thermoformed drip cover (figure 5.3A). The drip cover is secured by two nuts and can be removed. When removed, the AVT™ valve components can be viewed (figure 5.3B).

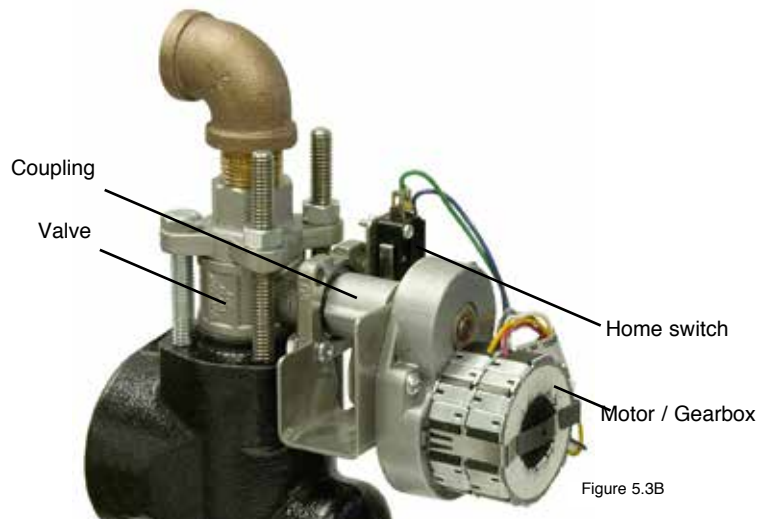
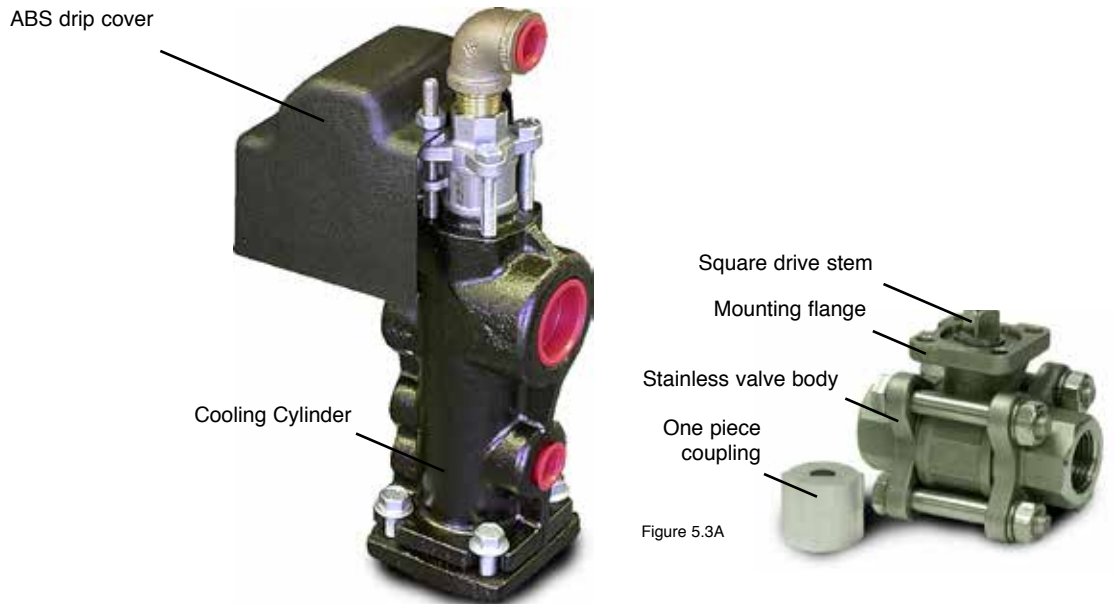

- B. The conditions that require servicing of the AVT™ modulating valve are as follows:
1. **Motor/gearbox assembly defective.** This condition is evidenced by non-movement of the motor when prompted by the instrument. This is evident when power is engaged

to the instrument. The instrument will turn the motor in an attempt to find "home base". If no movement is observed, most likely the motor/gearbox assembly is defective. To be certain, remove the motor as outlined below, maintain the electrical connection and supply power to the instrument. If the motor does not turn, the motor/gearbox should be replaced. If the motor does turn, the operator can determine the valve assembly is defective.

2. **Valve assembly defective.** The valve assembly may become fouled with process debris or the internal components may be defective.

C. The components of the AVT™ valve can be serviced separately. To begin the AVT™ valve service procedure, proceed with steps 1 - 5:

1. Disengage process operations and verify all system pressure is relieved and the unit's pressure gauges read "0".
2. Disengage main power supply and verify the *Power* light on the display is "off".
3. Remove the lift-off access panel and set aside.
4. Disconnect the valve wiring harness.
5. Remove the AVT™ valve's drip cover.

D. To service the motor driver/gearbox components, continue with steps 6 - 12:

6. The motor/gearbox assembly is mounted to the valve bracket and is secured by 2 mounting screws.

NOTE: It will also be necessary to remove the 2 screws that secure the micro switch to completely remove the motor since they are hard wired together.

7. Remove the 2 mounting screws. The motor and gearbox will now be loose. Carefully separate the motor/gearbox from the attached coupling from the valve assembly.
8. Align the motor/gearbox and coupling to the valve assembly.
9. Align the motor/gearbox assembly mounting holes to the holes in the cooling cylinder. Replace the 2 mounting screws and loosely install the microswitch screws.
10. Reconnect the wiring harness. Home base is the reference point from which the controller is able to open the valve incrementally. If the unit is not able to find home, a valve fault "ULU" will appear in the *Temperature* display window.

Adjust the home switch to clear the fault.

11. **Adjusting the home switch.** Apply power. The coupling should begin to turn. When the lobe on the coupling is directly under the roller for the microswitch, turn off the power. Adjust the microswitch so that the roller fully depresses the microswitch. Turn on the power and the valve should turn forward and backwards a few times and then stop at the home position. The valve light should be green and you may begin operation. See diagram on next page.

NOTE: Important... the valve stem should be in this position (as indicated in the diagram) and the valve should be CLOSED. If the valve is open, manually turn

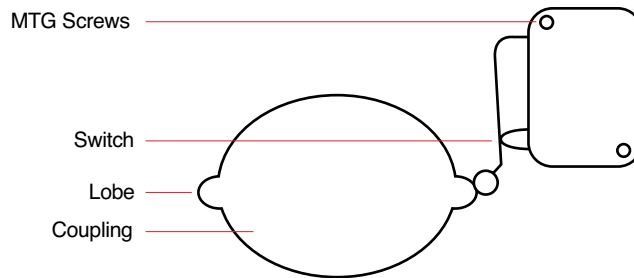

the square stem 90° so that the valve is closed.

- E. To service the valve components, continue with steps 13 - 20:
 12. Be certain the unit is totally depressurized with the unit's pressure gauges reading "0". The unit should be drained if possible.
 13. The valve assembly is a ball valve specially designed only to work with the AVT™ motor. The valve assembly is secured to the cooling cylinder by a top plate and 4 mounting screws. The drain connection originates at the valve top plate with a brass elbow and close nipple fitting. The connection can be maintained when servicing the valve.
 14. Remove the 4 mounting screws. The top plate, mounting bolts, valve assembly and the mounting plate with the attached micro-switch will now be loose. Carefully separate the valve from the motor/gearbox.
 15. At this step, the valve can be rebuilt or replaced. To rebuild the valve, order PN 8764939, and install new stem packing O-ring, seal rings, and seats (see diagram below). Once the valve is back together, continue with **step 17**:
 16. Aligned the valve assembly coupling to the motor/gearbox and place on the cooling cylinder. A gasket or seal is not required.

17. Replace the top plate, the micro switch mounting plate and the 4 mounting bolts. Tighten the 4 mounting bolts alternating to the opposite bolts.
18. Once power is reapplied, the instrument will align the AVT™ modulating valve to “home base”. Home base is the reference point from which the controller is able to open the valve incrementally. Process operations can resume. If the unit is not able to find home, a valve fault *ULU* will appear in the temperature display. Readjust the home switch to clear the fault. Adjust the home switch as needed (as outlined in Step 11).

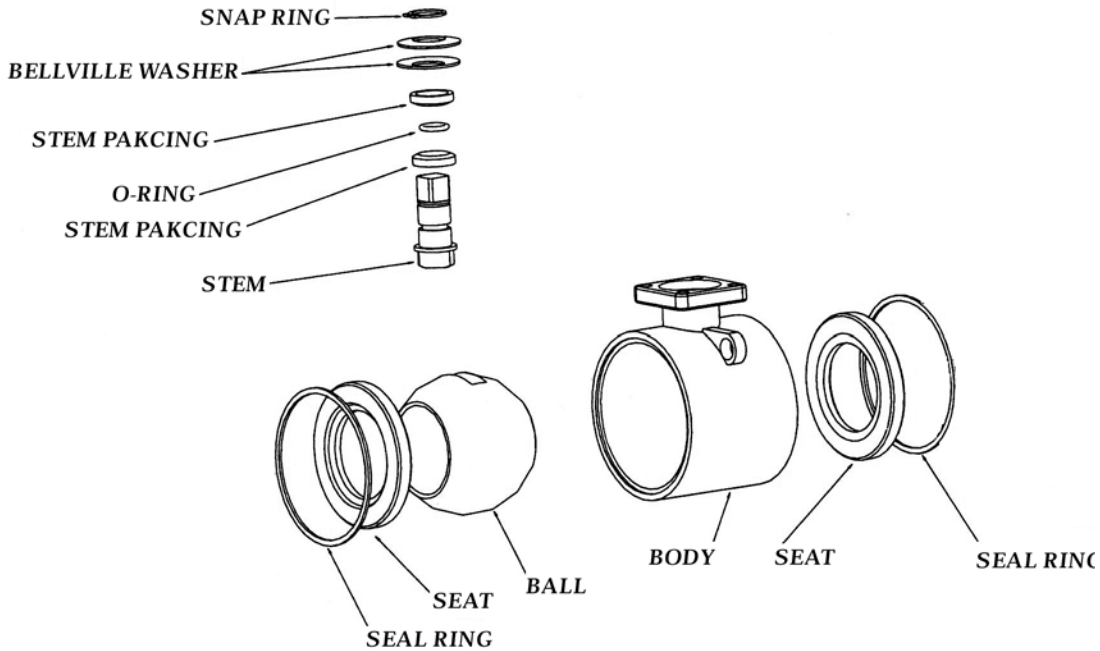

5.4 PROBE CALIBRATION

- A.** The temperature probe (figure 5.4A) is a temperature transducer. The transducer is embedded into a threaded bulb well. The transducer converts the temperature of the water into a proportional current output, which the microprocessor controller reads, displays, and bases its controlling functions. The gain is automatically calibrated within the microprocessor electronics. The zero adjustment potentiometer is located on the CPU.

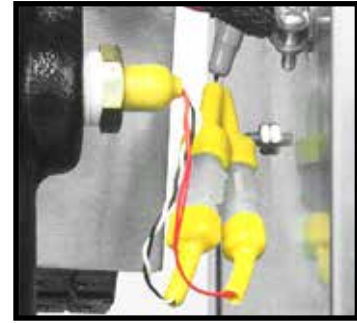

Typical sensor probe

Figure 5.4A

- B.** The temperature transducer and instrument circuitry is very stable. A small drift may occur over time. To ensure correct temperature reading, calibrate the probe annually or per your facility calibration standards. Operation in high humidity and high vibration environments may require more frequent calibration.

- C.** The operator should follow this procedure to calibrate the probe.

1. Disengage process operations and verify all system pressure is relieved and the unit's pressure gauges read "0".
2. Disengage main power supply and verify the *Power* light on the display is "off".

3. Remove the *To Process* temperature probe and insert a 1/2" plug in its place (figure 5.4B). To complete the calibration procedure, the unit will be operated at full flow and pressure. The plug is to maintain the mechanical integrity of the unit during the calibration procedure.

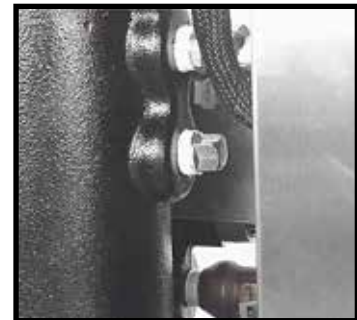

Plug

Figure 5.4B

4. Prepare an ice water bath. The operator should place an accurate digital thermometer in the ice water bath to read the temperature of the bath. The probe will be calibrated to the temperature of the ice water bath.
5. Place the probe in the ice water bath.
6. Start the unit.
7. Reduce the unit's set point, via the *Down Arrow* push button to 32°F.

8. With the unit in the operations mode, the “to process” temperature on the display should equal the temperature of the ice water bath as indicated by the digital thermometer. If not, the operator must change the calibration of the probe.
 - a. To access the calibration potentiometer, open the electrical cabinet panel door. The panel door is secured by a support strap. Caution must be employed when the electrical panel door is open since power is applied to the unit.
 - b. Locate the instrument CPU. The calibration pot is located on the “mother board” of the instrument assembly (figure 5.4C).
 - c. Use a non-conductive device, to adjust the potentiometer. Adjust the potentiometer until the “to process” temperature on the display equals the temperature of the ice bath.

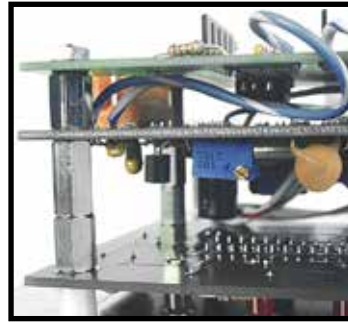

Calibration port

Figure 5.4C

9. When the two temperatures (“to process” and ice water bath) are equal, the calibration procedure is complete.
10. Shut down the unit. The operator must be certain to remove the 1/2” plug and replace the sensor probe. Restart operations.

5.5 VOLTAGE CHANGEOVER

- A. Some units can undergo a field voltage conversion by qualified technicians. Consult with the Advantage Service Department to determine if your unit can be converted. Have your Serial Number ready and call 317-887-0729.
- B. Typical Conversions for 1/2 to 7.5 horsepower motors and 10 to 16 kW heaters:
1. 240/3/60 to 480/3/60
 2. 480/3/60 to 240/3/60
 3. 480/3/60 to 208/3/60

Consult factory for other power conversions.

- B. For a field voltage changeover, the following items will require replacement or rewiring:
1. Heater (rewiring)
 2. Motor (rewiring)
 3. Transformer (rewiring)
 4. Motor starter and overload block (replace)
 5. Replace unit data tag with tag stating new voltage and amp rating.

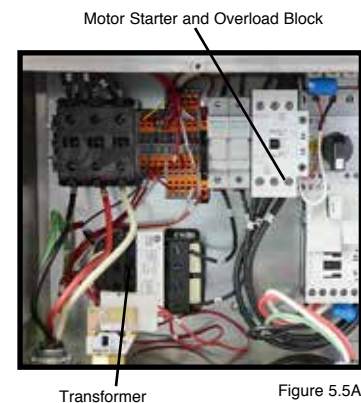

Figure 5.5A

- C. The qualified technician should follow this procedure to complete a field voltage changeover:

1. Disengage operations and verify all system pressure is relieved and the unit's pressure gauges read "0".
2. Disengage main power supply. **Follow proper lock-out procedures.** The operator must verify the *Power* light on the display is "off".
3. Remove the lift-off access panel and set aside. (figure 5.5A)
4. Rewire the heater to the new voltage. Figure 5.5B shows the wiring for 230 and 460 volt heaters.



Thermoformed panel removed and electrical cabinet open.

Figure 5.5A

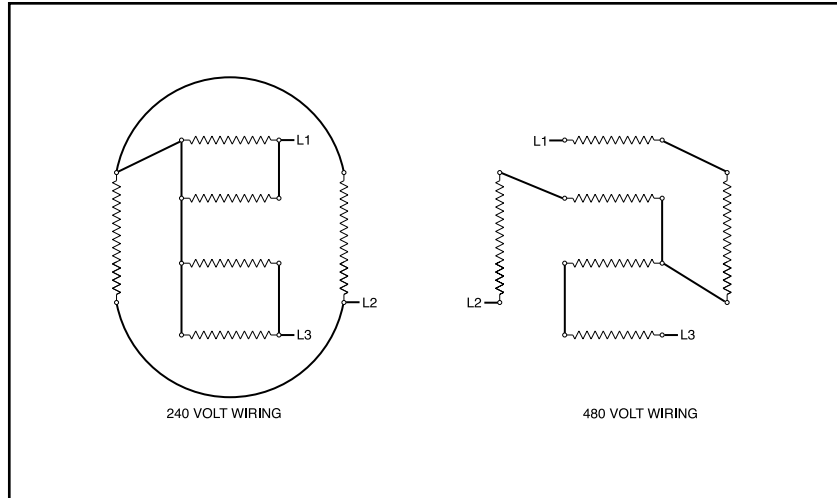

Wiring schematics for 240 and 480 volt heaters

Revised 4/11

Figure 5.5B

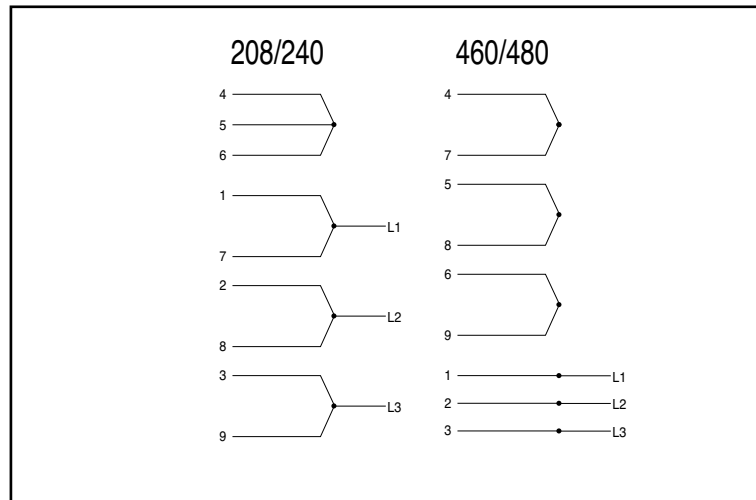

Wiring schematics for 240 and 480 volt pump motors

Figure 5.5C

5. Remove the thermoformed front panel and open the electrical cabinet panel door. Unplug the instrument connectors to fully extend the hinged panel.
6. Rewire the pump motor for the new voltage. Most Sentra pump motors are dual voltage. Figure 5.5C shows the wiring schematic for 240 and 480 voltages.
7. Rewire the transformer to the proper voltages as shown by the schematic



Transformer

Figure 5.5D

on the transformer (figure 5.5D).

8. Replace the motor starter and overload block. Adjust the overload block settings for the current draw at the new voltage (figure 5.5E).
9. Once a voltage change is complete, be certain the unit is properly connected to the new voltage supply, as outlined in **section 2.5** of this manual. Restart unit operations according to **section 3** of this manual.

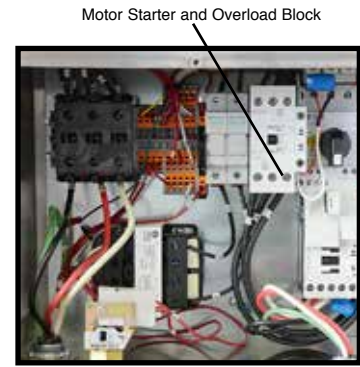
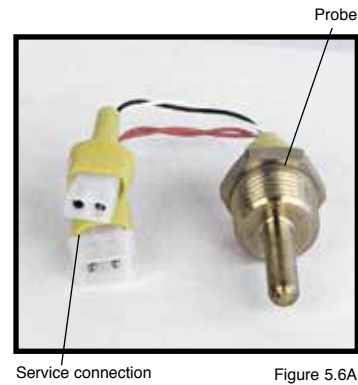

Figure 5.5E

5.6 SENSOR PROBE SERVICE

- A. Each temperature probe (figure 5.6A) is a temperature transducer. The transducer is embedded into a bulb well, which is threaded into the tank. The transducer converts the temperature of the water into a proportional current output, which the microprocessor controller reads, displays, and bases its controlling functions on. The gain is automatically calibrated within the controller electronics; the zero adjustment potentiometer is located on the CPU.



- B. Sensor probe errors are indicated by the *Probe* light on the instrument with a *Flashing Red* display. When a sensor probe error is displayed, take the following steps to correct:
1. **RECONNECTION.** If the service connection of the sensor probe becomes saturated with water. Simply unplug the connection, shake out the water to clear the service connection and replug. If this was the problem, the error display should change to *Solid Red* which can be cleared by pressing the *Start* push button. If not, continue with replacement.
 2. **REPLACEMENT.** Replacement of the sensor probe involves ceasing process operations (as outlined in section 3.4 of this manual) and removing the defective sensor probe. All factory supplied replacement probes are complete with the service connection. Unit with 'HE' Series instruments use two sensor probes: A "to process" and a "from process". The "high temperature limit" safety switch is a part of the "to process" sensor probe. To replace any sensor probe, follow the procedure as outlined below:
 - a. Stop process operations as described in **section 3.4** of this manual.
 - b. Determine that all process pressure is relieved and the unit's pressure gauges read "0" pressure.
 - c. Drain the unit by removing the pump casing drain plug. The unit can be drained only to below the sensor probe mount if preferred.
 - d. Disconnect the sensor probe service plug.
 - e. Using a crescent wrench, remove the sensor probe

from the cylinder. To install a new sensor probe continue as follows:

- f.** The new sensor probe threads should be lined with teflon tape and coated with leak preventative sealant. Using a crescent wrench, thread the new sensor into the machined boss of the cylinder.
- g.** Reconnect the service connection. Restart the unit as outlined in **section 3** of this manual.

5.7 PRESSURE SWITCH SERVICE

- A. The unit is protected from low pressure operations by a pressure switch (figure 5.7A). This switch is mounted at the bottom of the electrical cabinet.
- B. The switch will close and consent the control circuit when sufficient water supply pressure is presented. The switch is factory set to 20 psi.
- C. If insufficient water supply pressure is present, the switch will open and prevent operations.



Pressure switch

Figure 5.7A

- D. In cases where sufficient water supply pressure is present as indicated by the unit's pressure gauges and the pump is "off", and if the pressure switch fails to close, the pressure switch may be defective. To replace the pressure switch, follow the steps outlined:
 - 1. Shut down unit operations according to **section 3.4** in this manual. Be certain proper lock-out procedures are followed. Also, be certain system pressure is eliminated and the unit's pressure gauges read "0" pressure.
 - 2. Drain unit by removing the pump casing drain plug.
 - 3. A capillary runs from the cooling cylinder to the pressure switch. Remove the capillary connection.
 - 4. The brass elbow mounted on the pressure switch must be removed.
 - 5. Remove the electrical connections to the pressure switch.
 - 6. The pressure switch is mounted onto the electrical cabinet with two 1/2" nuts in series. Remove the nuts to remove the pressure switch. A new pressure switch from the factory should be installed by continuing with **step 7**.
 - 7. Thread one 1/2" nut onto the pressure switch and then place the pressure switch through the panel in the original mounting hole. Thread the second 1/2" nut from the bottom of the pressure switch. Tighten to lock the pressure switch in place.
 - 8. Install the brass elbow fitting. Teflon tape and leak preventative paste should be used to prevent water leakage. Install the capillary tube and resume operations.

5.8 INSTRUMENT SERVICE

A. The instrument controller is a microprocessor based instrument designed to cycle the heater and AVT™ modulating cooling valve to maintain process temperature at setpoint (figure 5.8A) .



Sentra HE instrument

Figure 5.8A

B. The instrument is not a field serviceable component. If the instrument is determined to be in need of repair, the operator must remove the assembly and return it to the factory for repair.

C. To service the instrument, take the following steps:

1. Disengage process operations according to the procedure outlined in **section 3.4**. The operator must be certain all system pressure is relieved and the unit's pressure gauges read "0".

2. Disengage main power supply and verify the *Power* light on the display is "off".

3. Remove the thermoformed front panel and set aside. The panel is attached to the stainless steel cabinet by 4 small screws.

4. Open the hinged electrical cabinet panel cover. The panel is opened by removing four small screws.



Connections

Figure 5.8B

5. The instrument is mounted on the electrical cabinet panel cover. The instrument is secured by four mounting bolts. A series of electrical connections link the instrument to the mechanical components of the unit (Figure 5.8B).

5. Remove the large molex connector.

6. Remove the ground terminals.

7. Remove the sensor plug.

8. Remove the four mounting nuts. The instrument is now loose and can be removed. To reinstall a factory issued instrument, continue with step #9.
9. Place the instrument into the panel mount, aligning the four mounting stems. Once the instrument is aligned, tighten the nuts to secure the instrument.
10. Connect the sensor plug.
11. Connect the ground terminals.
12. Connect the large molex connector.
13. The operator can now start the unit as outlined in **section 3** of this manual. The operator must reconfigure (if necessary) the instrument to restore the preferred operating parameters.

5.9 ELECTRONIC INSTRUMENT REPAIR POLICY AND PROCEDURE

- A.** All control instruments used in Advantage temperature control units are covered by the machine's warranty. Proprietary 'tailor made' instrument are manufactured specifically for Advantage by our affiliated company Advantage Electronics.
- B. IN WARRANTY SERVICE INCIDENT**
1. Call the factory for diagnostic assistance.
 2. If a control instrument is determined to be at fault, a new or reconditioned instrument will be sent as a replacement.
 3. Return the defective instrument freight pre-paid for full credit. If the defective instrument is not returned you will need to pay for it.
- C. OUT OF WARRANTY SERVICE INCIDENT**
1. Call the factory for diagnostic assistance.
 2. If a control instrument is determined to be at fault, you will be referred to the instrument manufacturer, Advantage Electronics (an Advantage Engineering affiliated company). There are 3 options.
 - a. Purchase a new instrument as a replacement.
 - b. Send your instrument back for repair, freight prepaid. For a nominal fee, your instrument will be repaired and returned.
 - c. Purchase a new instrument and repair the old one as a back up.
 3. If you are sending your instrument back for repair, call the Service Department for more information. Do not disassemble the instrument.
- D. Other Information:**
1. Call the factory for current repair charges.
 2. Repair warranty: 1 year.
 3. Ship to Advantage Electronics, 525 East Stop 18 Road, Greenwood, IN 46143. Attention: Repairs (317-887-1946). Include in the shipping box: Part, purchase order, contact name, phone number, and symptom (if available).
 5. For Priority service, send the instrument to the factory via overnight shipment. We usually repair these instruments the same day we receive them.



5.10 FLOW METER SERVICE

- A. The 'HE' instrument uses a flow meter assembly mounted at the base of the cooling cylinder. Figure 5.9A shows a "cut-away" view of cooling cylinder with the flow meter assembly installed.
- B. The operator can determine if the flow meter requires service when the *Flow* display on the 'HE' instrument reads "0" or unusually erratic readings during operations.
- C. The performance of the flow meter may be hindered due to excessive water pressure, excessive water velocity, and poor water quality.
- D. The operator should follow this procedure to service the flow meter components:



Figure 5.9A

1. Reduce process water temperature to below 85°F. Disengage process operations. and verify all system pressure is relieved and the pressure gauges read "0".
2. Disengage main power supply and verify the *Power* light on the display is "off".
3. Remove the lift-off access panel to access the cooling cylinder (figure 5.9B). The cooling cylinder is mounted to the suction side of the pump casing.
4. Disconnect the AVT™ valve cable, the hall effect sensor cable, the pressure gauge and pressure switch lines.
5. Remove the 4 mounting bolts that hold the cooling cylinder to the pump volute. Lift the cooling cylinder vertically off the pump to expose the magnetic rotor assembly.

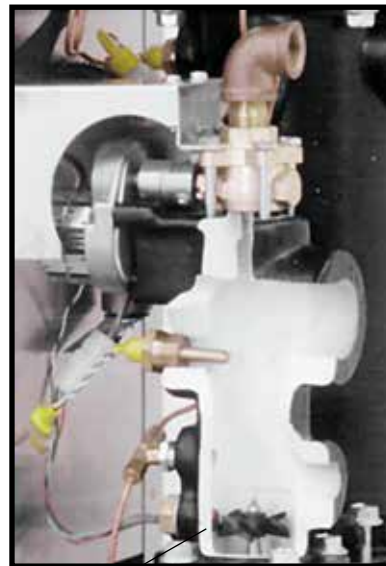

Flow Meter

Figure 5.9B

6. Inspect the magnetic rotor for damage or accumulation of debris and contaminants. Clean or replace the rotor as necessary (figure 5.9C). The magnetic rotor may be detached from the spindle by removing the lock nut.

7. Clean the tip of the hall effect sensor. The sensor is mounted in the cooling cylinder.

8. Clean the spindle and ring assembly.

9. The pump casing provides a recessed mounting for the magnetic rotor assembly. When reassembling the cooling cylinder to the pump casing, be certain the stainless steel ring and magnetic rotor assembly is secured in the recess mounting. Care should be taken when reinstalling the cooling cylinder as not to disturb the alignment of the magnetic rotor assembly. Replace the tank gasket.

10. Reinstall the 4 mounting bolts, alternating to the opposite bolt when tightening.

11. Reinstall the pressure gauge line, the AVT™ cable and the pressure switch line.

12. Restart the unit as outlined in **sections 2 and 3** of this manual. Check the system for any leaks around the process connections and repair if required.



THIS PAGE INTENTIONALLY BLANK

6.0 SENTRA COMPONENTS
6.1 MECHANICAL SYSTEM
6.2 ELECTRICAL SYSTEM



6.1 MECHANICAL SYSTEM

A. MOTOR/PUMP ASSEMBLY. The unit pump is a multi-component assembly serving to circulate water through the process system. The pump will increase the system pressure between 35 - 50 PSI over the plant water supply pressure. The pump is driven by an electrical motor.

1. **Pump casing.** The pump casing is an exclusive design. The casing is cast of iron and flanged to accept the heater/discharge and cooling tanks. The casing is the support element in the pump/motor assembly and is secured to the unit base (figure 6.1A).

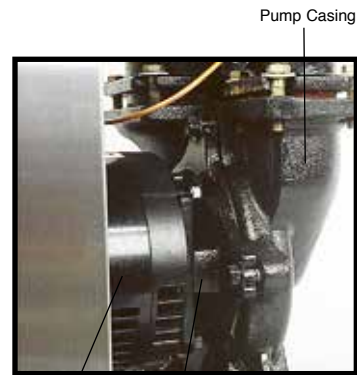

2. **Pump adapter.** The pump adapter is the mating element between the pump casing the electric motor. The adapter is machined to accept the pump seal flush line. The stationary pump seal member is set in the seal cavity of the pump adapter (figure 6.1A).

3. **Electrical motor.** The electric motor is a dual voltage, 3 phase, ODP motor. The motor serves to turn the pump impeller creating process flow (figure 6.1A).

4. **Impeller.** The impeller is custom designed for the unit and creates the higher flow (gpm) from standard HP ratings (figure 6.1B).

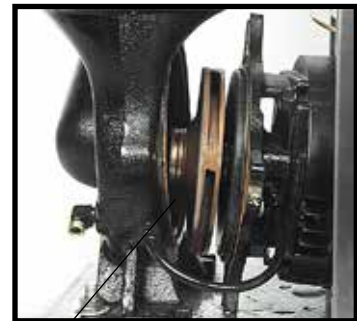

5. **Pump Seal.** The pump seal prevents water leakage from the pump adapter. The seal is made up of three items: The stationary member (seated in the seal cavity), the rotating member (placed on the motor shaft) and the tension spring (figure 6.1C shows the stationary member only).



6. **Pump seal flush.** The

pump seal flush is a flow diverter which serves to “cleanse” the pump seal assembly of debris which may lodge on the seal and create a leak (figure 6.1D).

B. HEATER. The heater is a dual voltage, flange mounted immersion heater set in the pump discharge cylinder. The heater elements have a stainless steel sheath. Electrical supply to the heater is provided via a mercury contactor (figure 6.1E).

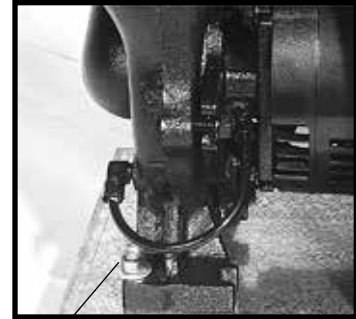

Seal flush tube

Figure 6.1D

C. HEATER/PUMP DISCHARGE CYLINDER. The heater/pump discharge cylinder is a custom cast tank. The tank is flanged mounted to the pump casing. Reinforced machined bosses accept the “to process/high temperature limit” sensor probe and the “to process” connection (figure 6.1E).

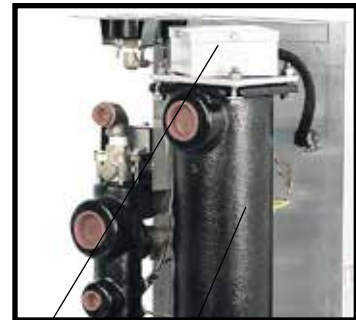

Heater

Discharge tank

Figure 6.1E

D. COOLING CYLINDER. The cooling cylinder is a custom cast tank. The tank is flanged mounted to the pump casing. Reinforced machined bosses accept the pressure relief valve, the “from process” pressure gauge and pressure switch capillary connector, AVT™ modulating cooling valve, the “water supply connection” and the “from process” connection (figure 6.1F).

AVT valve



Figure 6.1F

E. PRESSURE RELIEF VALVE. The pressure relief valve is a 150 psi relief valve serving to discharge excessive unit pressure to atmosphere. The valve can be manually activated by lifting the actuating lever (figure 6.1F).

F. AVT™ VALVE. The AVT™ valve is a patented Advantage design using a motor/gearbox assembly to open in minute increments from 0 to 100% a custom ball valve assembly. The AVT™ valve is controlled by custom programming of the instrument (figure 6.1F).

G. PRESSURE GAUGES. “To” and “from” process pressure gauges display the system pressure. “To process” pressure originates at the heat/pump discharge cylinder. “From process” pressure originates at the cooling cylinder. The gauges accurately display system pressures from 0 to 160 PSI (figure 6.1G).

H. CASTERS. The unit is mounted on 4 swivel ball bearing casters. The casters allow the unit to be portable and easily move from location to location.



Figure 6.1G

I. STAINLESS STEEL CABINETRY. The stainless steel cabinetry prevents unsightly rust and metal decay. The electrical cabinet cover is hinged. The unit base is made of pressed steel with galvanized zinc coating. The lift off access panel is secured to the unit base by 5 screws (figure 6.1G).

J. FLOW METER. The flow meter is an assembly made of non-ferrous material designed to detect and display process flow. A rotor with 4 magnetic poles with a bronze bearing spins on a stainless steel spindle/ring assembly. This assembly is set inside the cooling cylinder. The rotor spins with the process flow. A hall effect sensor records each spin of the rotor and the instrument interprets and displays the flow (figure 6.1H)

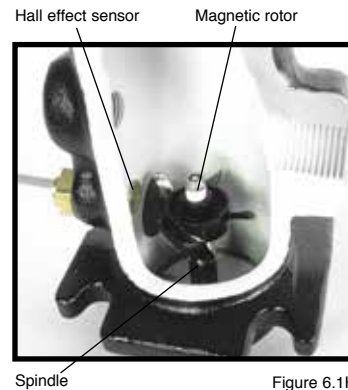
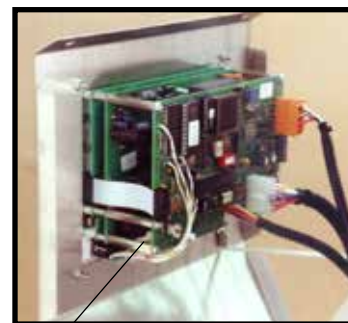

Figure 6.1H

6.2 ELECTRICAL SYSTEM

A. INSTRUMENT. The instrument is a custom designed and assembled microprocessor controller. The instrument is mounted to the electrical panel cover. The instrument controls the cycling of the heater, motor pump and AVT™ valve. System and setpoint temperatures are displayed continually. System parameters are programmable (figure 6.2A).



Typical instrument with service connections removed

Figure 6.2A

B. TRANSFORMER. The transformer supplies 110 volts to the controlling instrument (figure 6.2B).

C. PUMP MOTOR CONTROLLER. The electrical motor is engaged when the motor starter contacts close, on command by the instrument. The electric motor is protected from excessive amperage by a set of thermal overload relays, which open when excessive amperage “heats” the overloads and the relay opens (figure 6.2B).

- D. **HEATER CONTACTOR.** The heater contactor is a solid state contactor. On command from the instrument, the contactor will close and voltage will be supplied to the heater (figure 6.2B).
- E. **PRESSURE SWITCH.** The electric panel mounted pressure switch will close when sufficient pressure is supplied to the unit (20 psi). A closed pressure switch will consent the control circuit to the instrument controller to allow process operations (figure 6.2B).
- F. **SENSOR PROBES.** The unit uses two sensor probes. The “to process” temperature sensor and the “high temperature limit” safety switch” are housed in the same assembly and mounted in the heater/pump discharge tank (figure 6.2C). The “from process” probe is mounted in the suction tank.
- G. **POWER CORD.** The supplied power cord is factory installed to the unit. The power cord is a 3 conductor with 1 ground wire sized for the unit and 10’ in length.

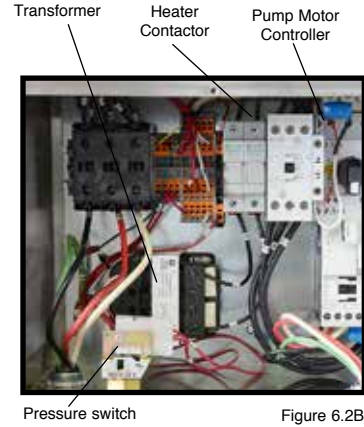

Figure 6.2B

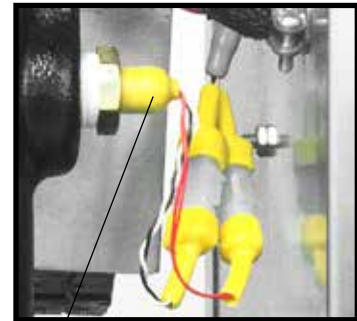

Figure 6.2C

THIS PAGE INTENTIONALLY BLANK

7.0 RELATED DRAWINGS

- 7.1 SENTRA PHYSICAL
- 7.2 SENTRA ELECTRICAL
- 7.3 SENTRA CIRCUIT SCHEMATIC
- 7.4 SENTRA REGULATOR/BYPASS INSTALLATION
- 7.5 SENTRA DUAL ZONE DOLLY
- 7.6 SENTRA STACKING RACK



7.1 SENTRA PHYSICAL

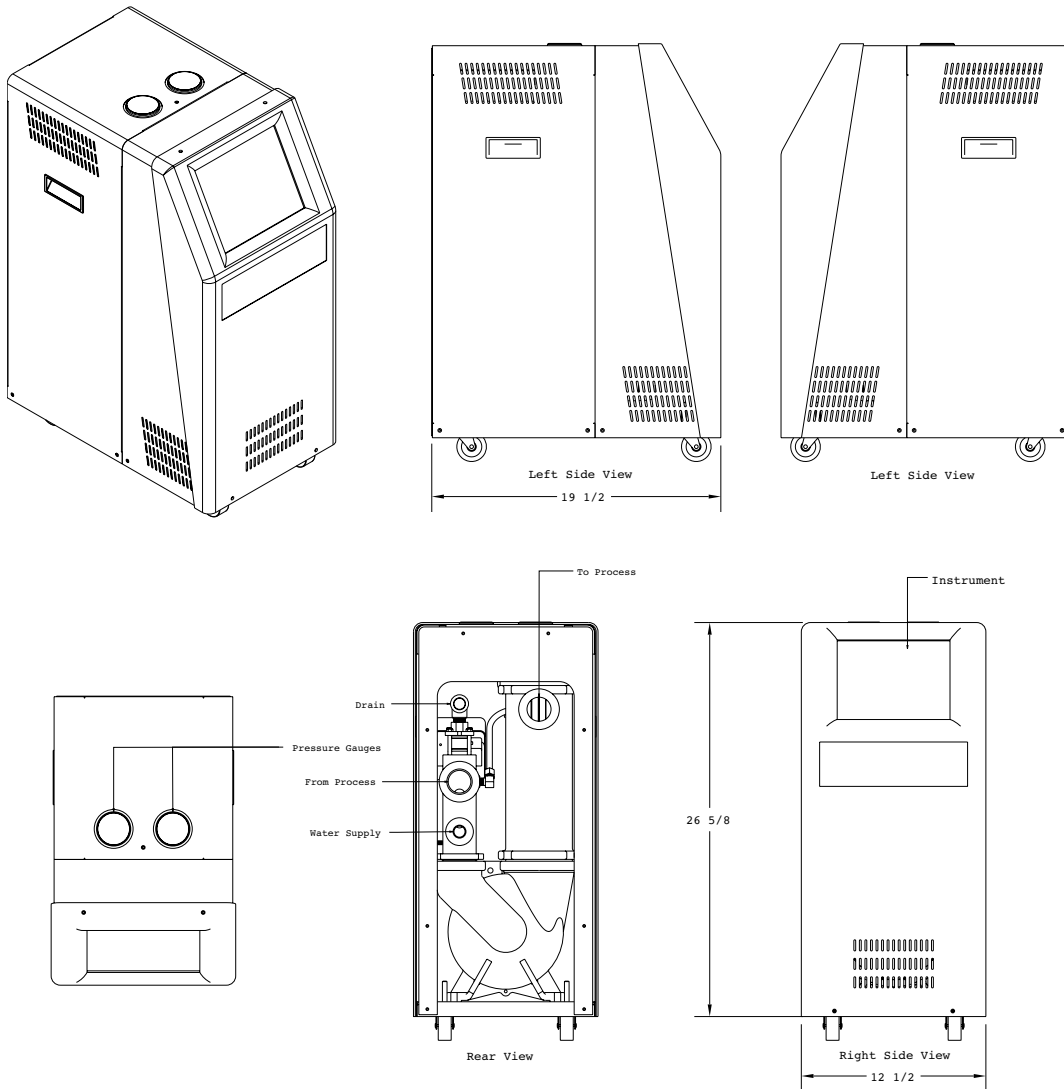

7.2 SENTRA ELECTRICAL

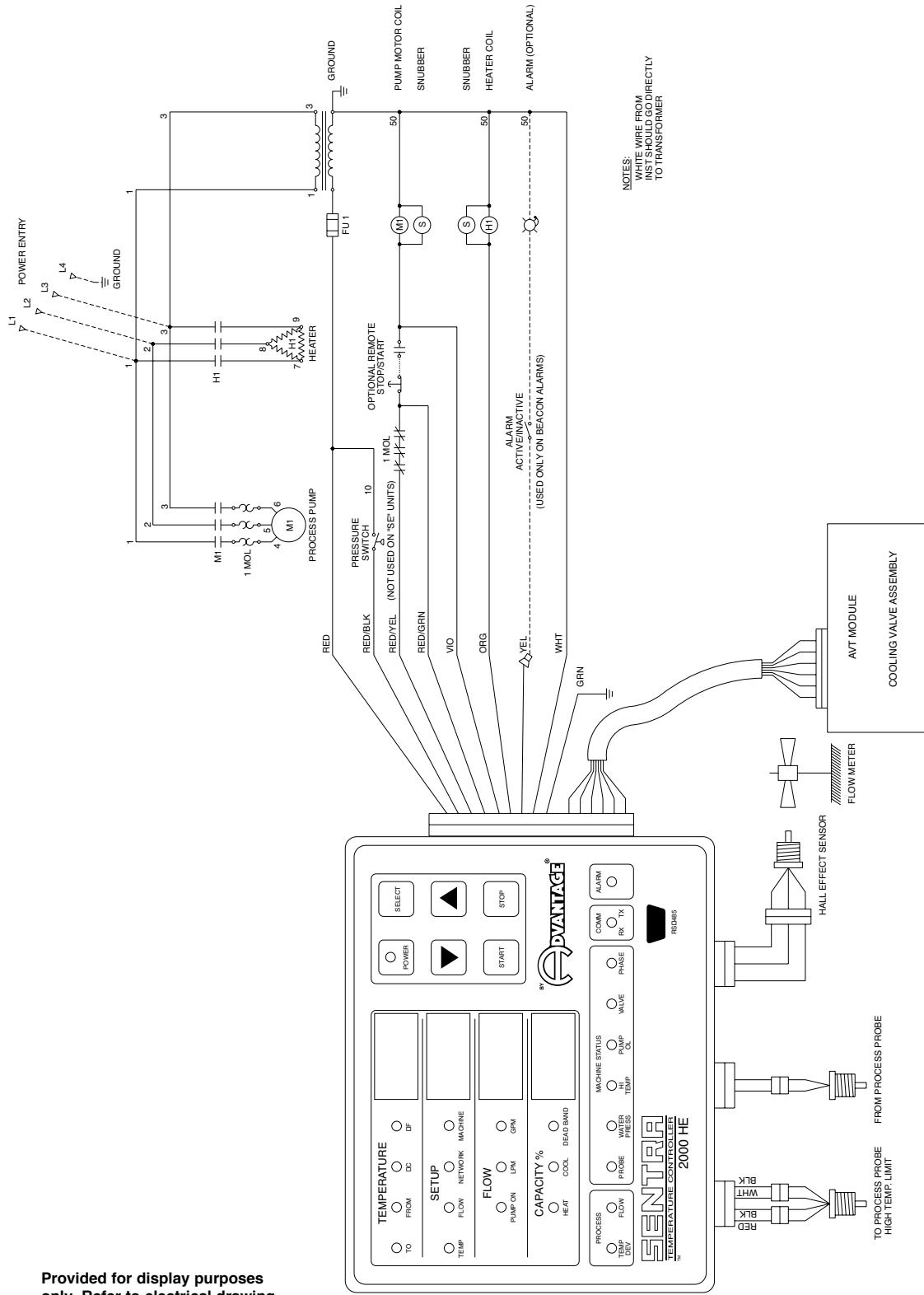

Provided for display purposes only. Refer to electrical drawing supplied with unit for details.

7.3 SENTRA HE CIRCUIT SCHEMATIC

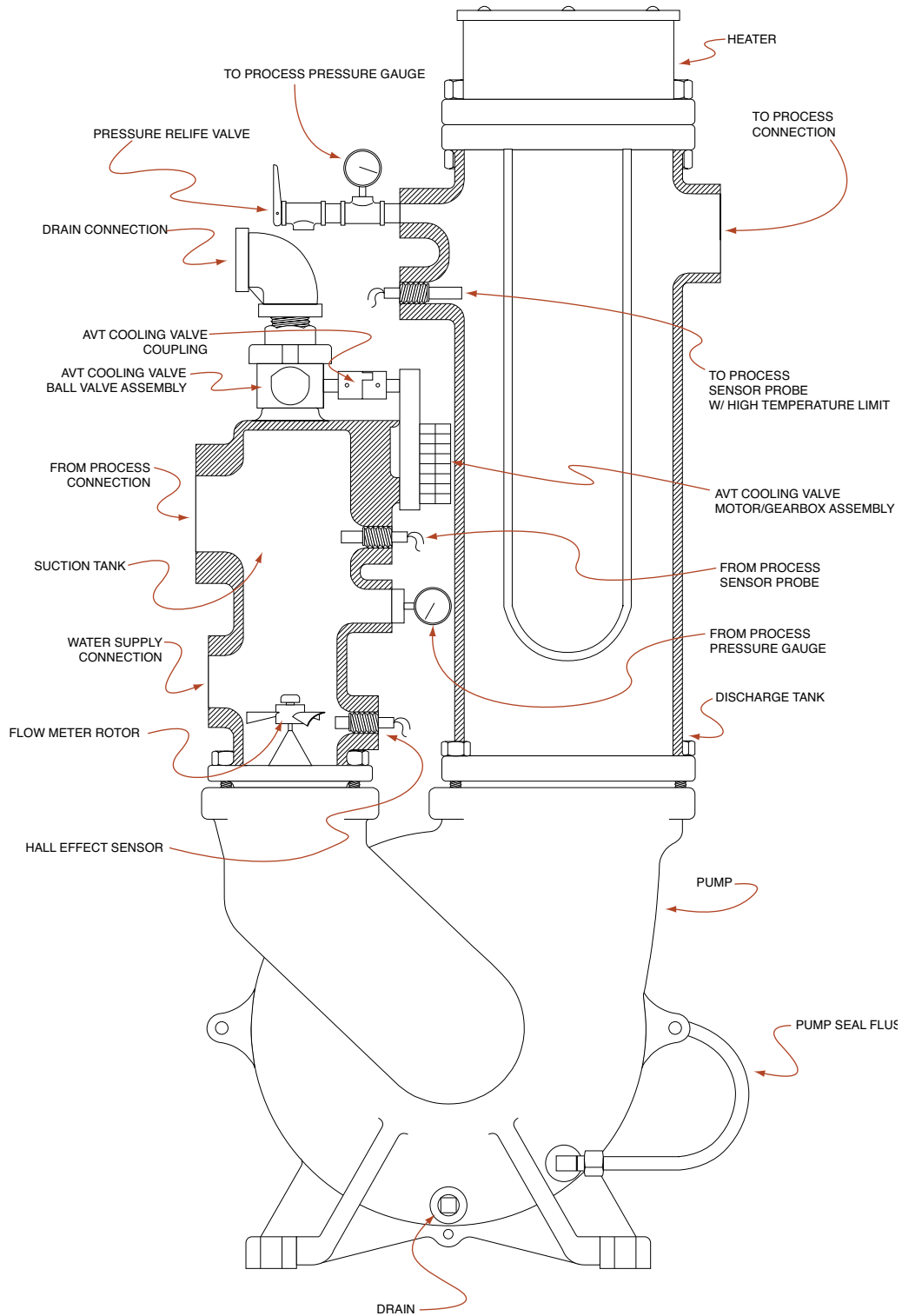

7.4 SENTRA REGULATOR/BYPASS INSTALLATION

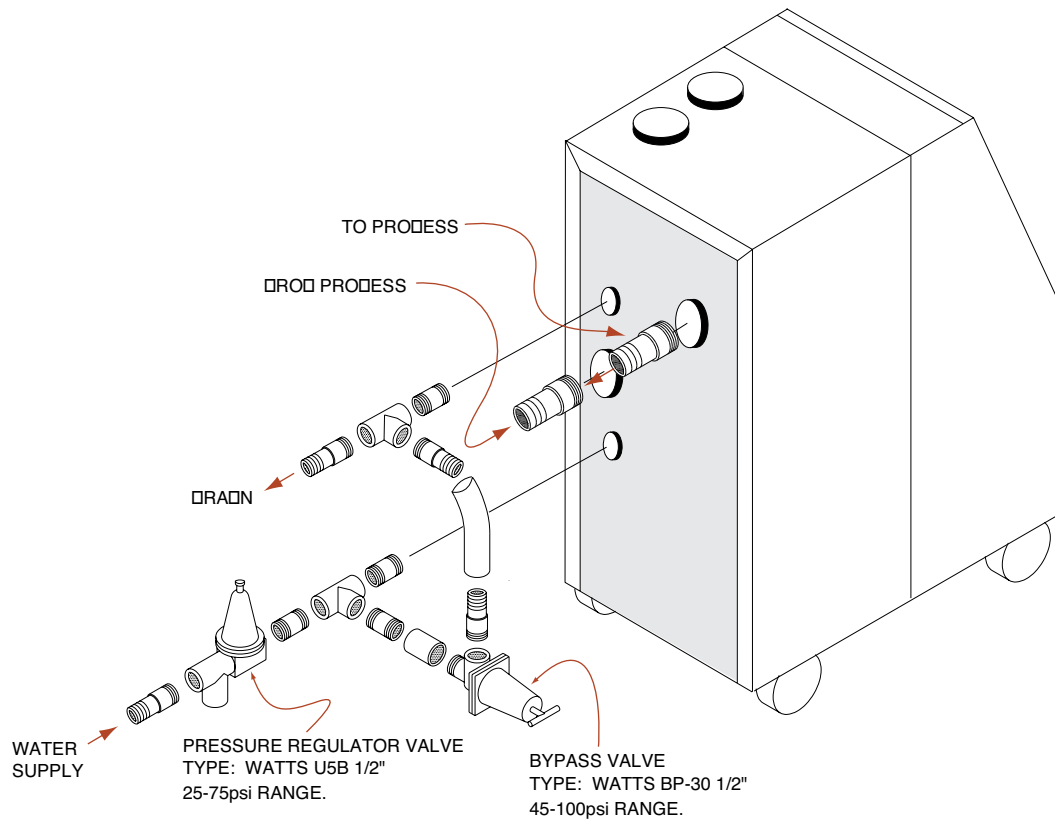

7.5 SENTRA DUAL ZONE DOLLY

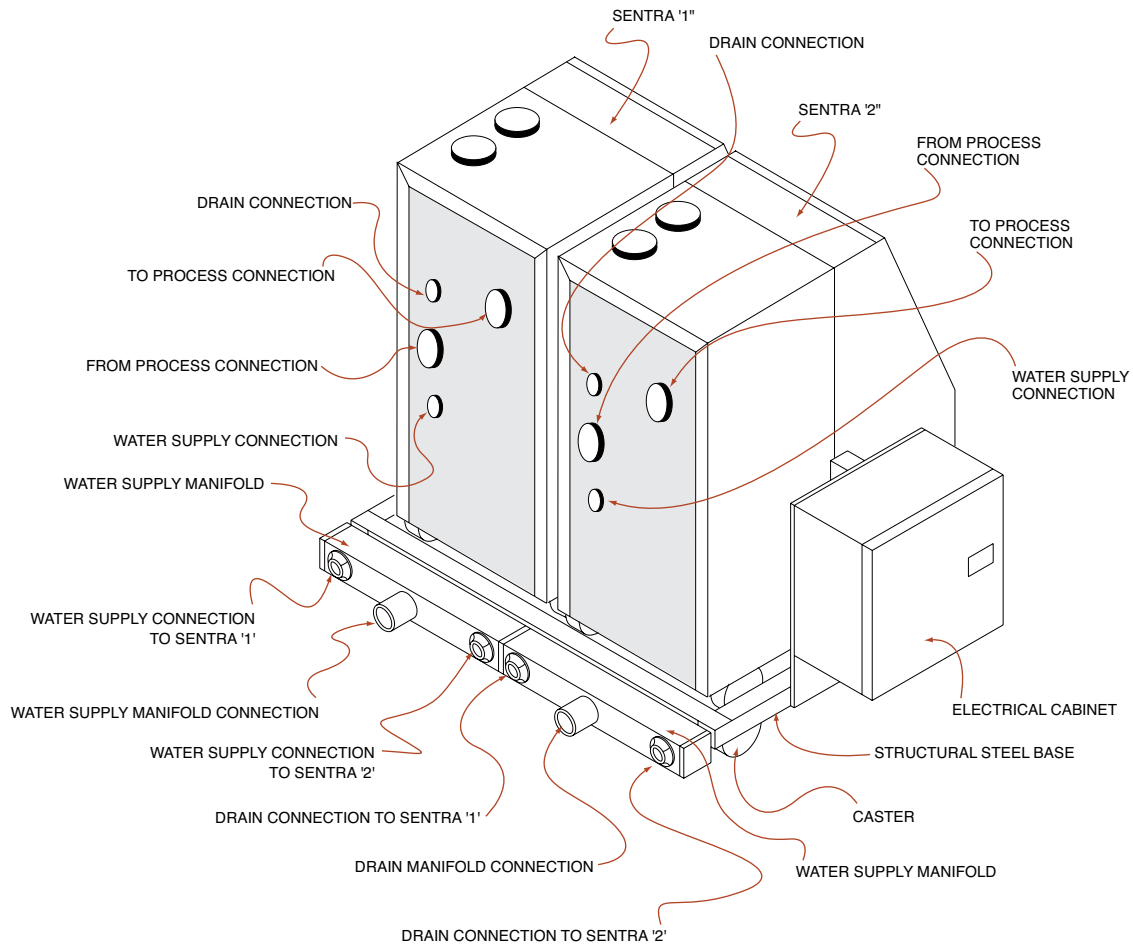

7.6 SENTRA STACKING RACK

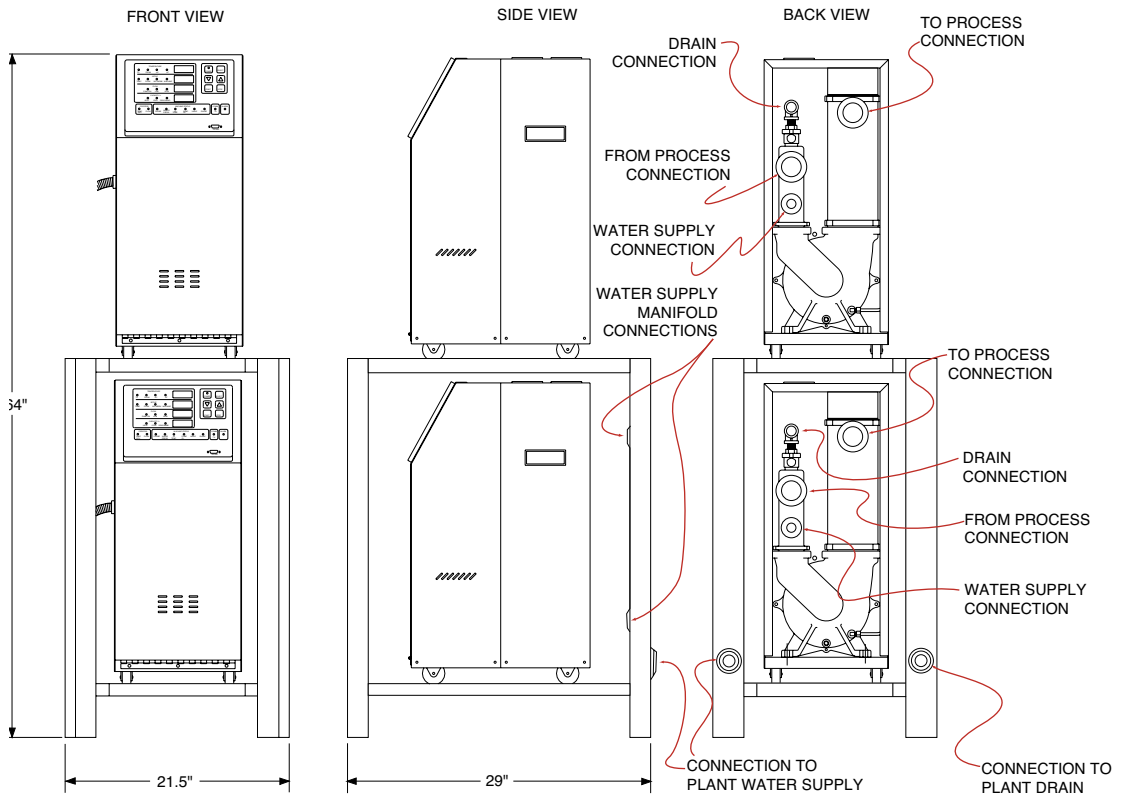

THIS PAGE INTENTIONALLY BLANK

8.0 APPENDIX

- 8.1** SENTRA MODEL # AND SUFFIX CODING
- 8.2** INTERPRETATION OF PROCESS PRESSURE GAUGES
- 8.3** OPERATION OF MOLD PURGE
- 8.4** CLOSED CIRCUIT OPERATION
- 8.5** DIP SWITCH USE
- 8.6** ADVANCE INSTRUMENT USE
- 8.7** SPI COMMANDS
- 8.8** COMMUNICATIONS CABLE
- 8.9** SECOND SETPOINT OPERATION
- 8.10** OPTIONAL ALARM OPERATION
- 8.11** AVT™ VALVE COMPONENTS
- 8.12** SENTRA AS5 PUMP PARTS LIST - 1/2 HP TO 1 HP
- 8.13** SENTRA AS5 PUMP PARTS LIST - 1.5 HP TO 3 HP
- 8.14** SENTRA PARTS LIST - HE INSTRUMENT



8.1 SENTRA MODEL # AND SUFFIX CODING

The data tag on your Sentra Temperature Control Unit provides general information about the unit. Compare the information below with your data tag for more information about your unit. Some data tags may have other or different information. If you need specific information about the configuration of your unit contact the factory with the serial number from your unit.

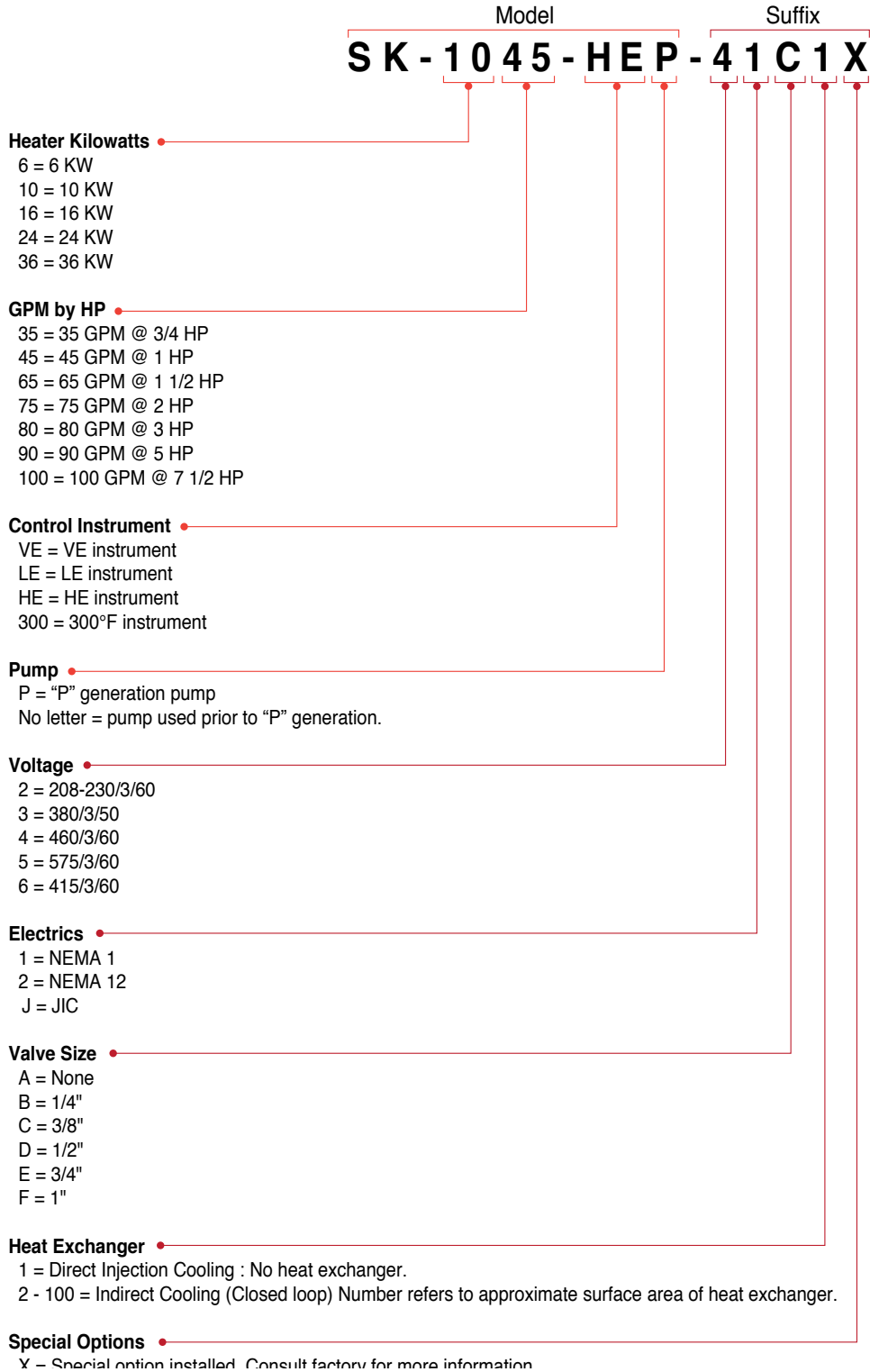

8.2 INTERPRETATION OF PROCESS PRESSURE GAUGES

A. READ AVAILABLE WATER PRESSURE AT UNIT'S LOCATION. When a temperature control unit is attached to the process with the water supply on and the pump off, both gauges will read the water supply pressure at the unit's location (figure 7.3A).



Pressure gauges

Figure 7.3A

B. READ PRESSURE DROP ACROSS PROCESS (ΔP). With the pump on, the "to process" pressure gauge will rise to read the sum of the water supply pressure and pump generated pressure. The "from process" pressure gauge reads the effect of water supply pressure and pump suction pressure. The difference between the to and from process gauges is the pump generated circulating pressure... which is also equal to the pressure drop across the process.

C. PUMP ROTATION INDICATION. If the pump is running, and both gauges are "close" to same value, it is likely that the pump is rotating backward, or the pump is generating such a high flow that an overload condition will result.

D. PUMP MOTOR OVERLOAD CONDITION. If the ΔP is low with the pump rotating correctly, then the flow rate is high, which probably will result in a motor overload. Refer to the representative pump curve below.

E. WATER HAMMER (COMPETITIVE SOLENOID VALVE UNITS). On competitive mold temperature controllers, when ΔP gauges are supplied, the water hammer effect of on/off solenoid valves can be seen. When the solenoid valve is open, both to and from process pressure gauges will fall as the system depressurizes. When the valve closes, there will be a momentary spike that will be seen on both pressure gauges, then they will settle back to normal ΔP values. This spike is called "water hammer".

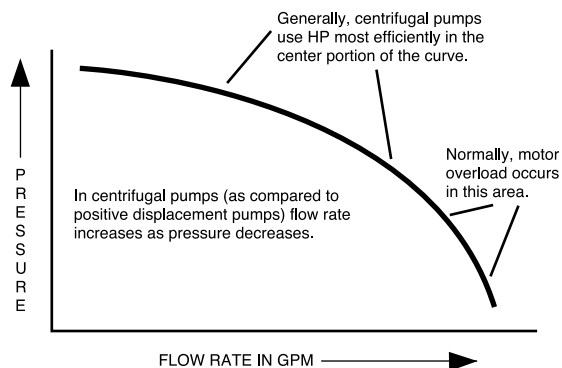

8.3 OPERATION OF MOLD PURGE

A. Advantage supplies an optional **MOLD PURGE** kit for temperature control units. The mold purge kit contains several solenoid valves and check valves. When activated and supplied with compressed air, the mold purge kit will expel process water from the mold to the central water supply or drain. Advantage mold purge kits are supplied as a factory installed option or a field retrofitted kit.

B. The operation of the mold purge is as follows (see illustration)

1. Stop the pump, maintain electrical power to unit.

2. Close the water supply ball valve.

3. Connect a regulated air supply to mold purge compressed air connection.

Note: Air supply should be regulated approximately 10 PSI above drain line pressure.

4. Activate mold purge with button located on electrical cabinet.

5. When water is purged disconnect air supply.

6. Depress and hold vent button (approximately 30 seconds to release air pressure.

7. Disconnect power to unit.

AIR AND WATER MOVEMENT DURING MOLD PURGE OPERATION

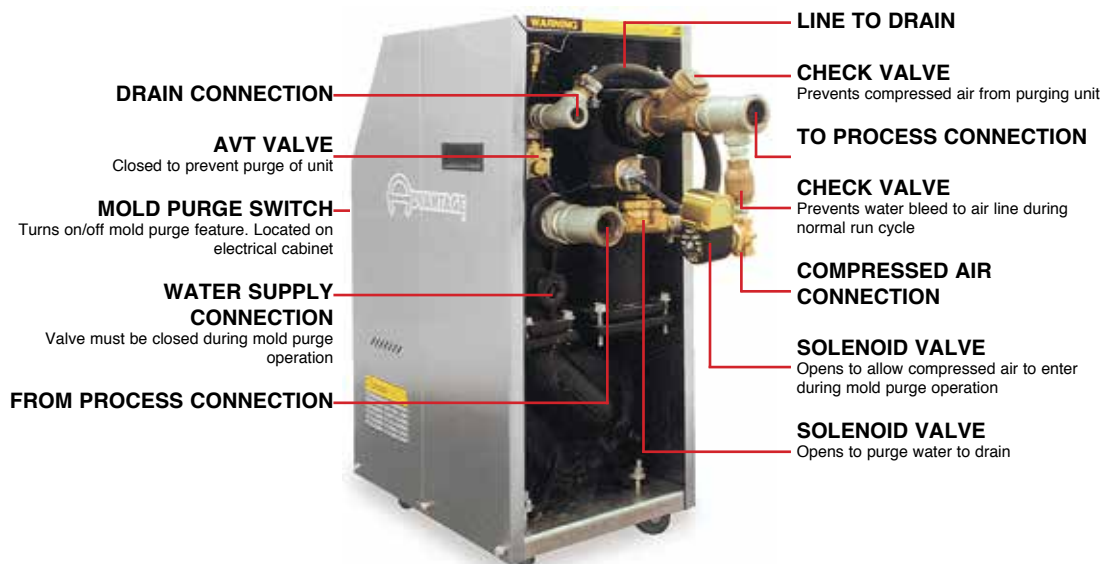
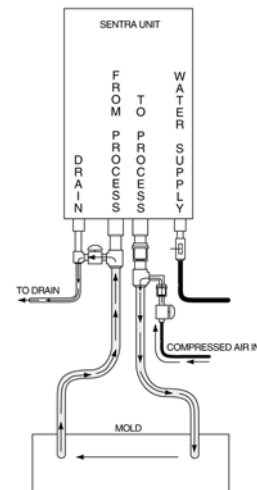

8.4 CLOSED CIRCUIT OPERATION

- A. Standard Sentra 'SK' mold temperature controllers are supplied as 'open-circuit' units. 'SK' units can be used on 'closed-circuit' applications with the installation of the 'SE' kit.
- B. Factory installed 'SE' kits place a heat exchanger into system to separate the cooling water loop from the process circulation loop. Cooling water from plant water supplies circulate only through the 'tube' side of the heat exchanger. Process water circulates through the 'shell' side of the heat exchanger.

C. To control process water temperature, a microprocessor controlled AVT™ modulating valve is installed on the heat exchanger drain line.

D. The closed circuit kit will add 10" to the overall height of the unit. The width and depth do not change, although the length of connection hose extending from the back of the unit must be accounted for.

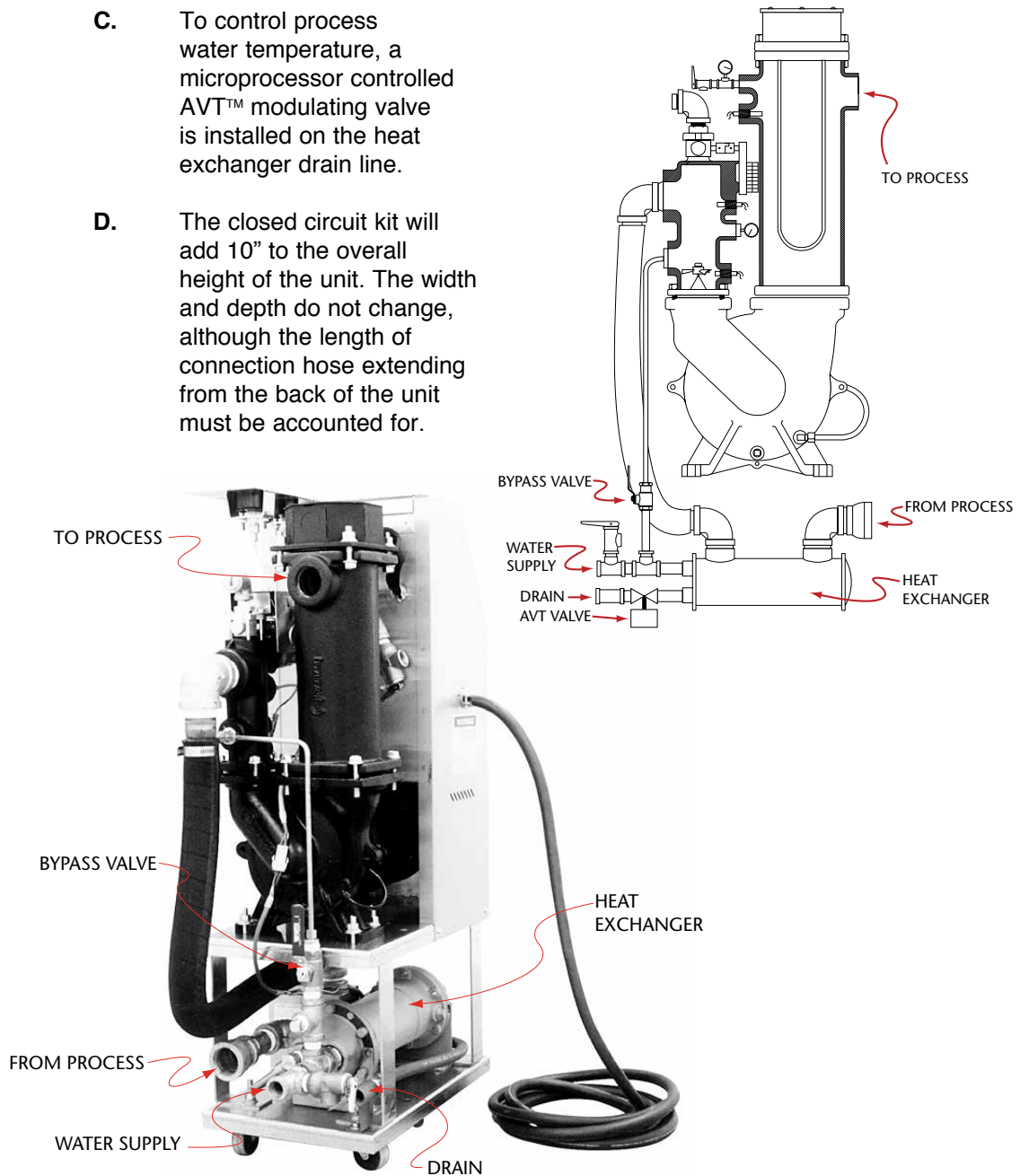

8.5 DIP SWITCH USE

A. DESCRIPTION

1. The 5 position DIP switch is located in the center of the CPU board and is used to set options for machine operation. The switches should only be changed when the instrument is turned OFF. Definitions of the 5 DIP switches are listed below.

B. DEFINITIONS

1. **SW1 - code page for EPROM.**
ON - (default) code page is active.
OFF - code page 1 is active.
2. **SW2 - extended configuration**
ON - (default) extended configuration is disabled
OFF - extended configuration is enabled
The display will show:
"AFL" - 'no'/'yes' Internal/Alternate Flow Sensor
"SP2" - 'no'/'yes' Disable/Enable 2nd Setpoint
"rSP" - 'no'/'yes' Disable/Enable Remote Setpoint
3. **SW3 - valve size**
ON - (default) 1/2", 3/8" (500 step) AVT valve is enabled
The display will show - "ULU" - '50' for 500 step Small valve
OFF - 3/4" (1000 step) AVT valve is enabled.
The display will show - "ULU" - '100' for 1000 step Large valve
4. **SW4 - remote start/stop**
ON - (default) remote start disabled
OFF - remote start enabled
5. **SW5 - heat only mode**
ON - (default) AVT valve operation is enabled
The display will show - "Ho" - 'no'
OFF - AVT valve operation is disabled
The display will show - "Ho" - 'yes'

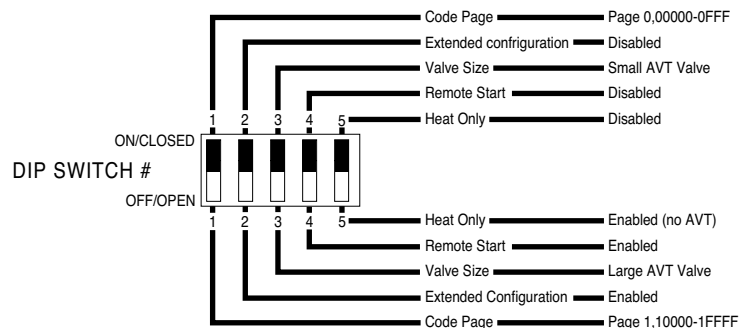

8.6 ADVANCED INSTRUMENT USE

- A.** When the instrument powers up, the display will go through a "WOW" mode where all LEDs are turned on for approximately 4 seconds. The version will scroll from right to left in the first (top) and second display windows. The display will then go into a *Stop* mode where all displays are OFF except the *Probe, Valve, Phase* and *Power* LEDs. When the *Start* push button is pressed, the instrument will enter the *Run* mode display as described below:

RUN mode display:

1. "TTT" - TO process temperature
2. "SSS" - SETPOINT
3. "FFF" - FLOW
4. "CCC" - CAPACITY

- B.** When the *Select* key is pressed, the 1 and 2 display will cycle through the following combinations. Display 3 and 4 will remain *Flow* and *Capacity* as above. Where indicated, with + - , the value of display 2 can be modified by pressing the *Up Arrow and Down Arrow* push buttons. If no keys are pressed within 5 seconds, the display will return back to the normal *To Process* display.

- C.** NORMAL Display Mode:

- | | | |
|-------|-------|----------------------------------------------------------------------|
| 1 | "TTT" | TO PROCESS temperature |
| + - 2 | "SSS" | SETPOINT local or remote + (SP2, if enabled) |
| 1 | "FFF" | FROM process temperature |
| + - 2 | "SSS" | SETPOINT local or remote + (SP2, if enabled) |
| 1 | "SP " | Setpoint - only when "rSP" equals "NO" |
| + - 2 | "SSS" | SETPOINT local - 0 to 250 |
| 1 | "rSP" | Remote Setpoint Select - Only when extended configuration is enabled |
| + - 2 | "Loc" | Local Setpoint Enabled - "rSP" equals 'yes' |
| + - 2 | "REn" | Remote Setpoint Enabled |
| 1 | "SPL" | Local Setpoint - Only when "rSP" equals 'yes' |
| + - 2 | "SSS" | Local Setpoint Value |
| 1 | "SPr" | Remote Setpoint - Only when "rSP" equals 'yes' |
| + - 2 | "SSS" | Remote Setpoint Value |
| 1 | "SP2" | 2nd Setpoint - Only when "SP2" equals 'yes' |
| + - 2 | "SSS" | 2nd Setpoint offset - +- 99, bounded by Setpoint |
| 1 | "HI " | High temp deviation limit |
| + - 2 | "HHH" | Limit - 0 to 30 |

- 1 "Lo " Low temperature deviation limit
- + - 2 "LLL" Limit - 0 to 30

- 1 "LoF" Low flow limit
- + - 2 "FFF" Limit - 0 to 999

- 1 "Pro" Protocol
- + - 2 "SPI" For SPI
- + - 2 "CAC" For CAMAC

- 1 "Adr" Protocol Address
- + - 2 " 1" thru " 99" for SPI
- + - 2 " 0" thru " 99" for CAMAC

- 1 "Rat" Protocol Baudrate
- + - 2 " 96" where 96=9600, 48=4800, 24=2400, 12=2400

- 1 "Unt" Temperature/Flow Units
- + - 2 " F" Fahrenheit/GPM
- + - 2 " C" Centigrade/LPM

- 1 "Ho " Heat Only, based on SW #5
- + - 2 "no " Not enable
- + - 2 "YES" Enabled

- 1 "ULU" Valve size, based on SW #3
- + - 2 " 50" small AVT valve
- + - 3 "100" large AVT valve

D. Extended Configuration Enabled by SW #2

- 1 "AFL" Alternate Flow sensor
- + - 2 "no " Internal, small flow sensor
- + - 2 "YES" Alternate, large flow sensor

- 1 "Int" No, internal, small flow sensor selected
- + - 2 "SSS" Calibration factor for small flow sensor

- 1 "ALT" Yes, alternate, large flow sensor selected
- + - 2 "LLL" Calibration factor for large flow sensor

- 1 "SP2" 2nd setpoint enable/disable
- + - 2 "no " Disable 2nd setpoint
- + - 3 "YES" Enable 2nd setpoint

- 1 "rSP" Remote Setpoint enable/disable
- + - 2 "no " Disable remote setpoint
- + - 2 "YES" Enable remote setpoint

8.7 SPI COMMANDS

- A. INTRODUCTION:** In 1987 a group of member companies of the Society of the Plastics Industries began development of a communication protocol for use by their processing and auxiliary equipment. Their goal was to allow the exchange of information between various pieces of equipment from different manufacturers to be simple and reliable. The result of their work was released in 1990 and has made the interconnection of equipment much easier and straightforward. There are now over 40 companies that offer the SPI Protocol in their products. This document details the implementation of the SPI Protocol available in the SENTRA 'SK' temperature controllers and MAXIMUM 'MK' portable chillers with HE instruments.
- B. PROTOCOL BASICS:** The SPI Protocol is described by a 2 part specification. The largest portion of the SPI Protocol specification deals with how basic information is exchanged between equipment. The second part of the specification details the actual pieces of information exchanged using the protocol. Items such as Process Temperature, Process Setpoint and Process Status are detailed in this part. This FYI will list the commands that are supported by ADVANTAGE equipment.
- C. EQUIPMENT SETUP:** The setup of equipment to be connected in an SPI Protocol network is simple. Each device must have a unique address for its device type and it must use the same data transfer rate as the other pieces of equipment in the network. There are many acceptable ways used to 'set' the device address and data rate. ADVANTAGE equipment provides access to the information via the front panel operators and displays. Other manufacturers may use internal DIP switches or jumpers.

A typical cell may be configured as follows:

Data Transfer Rate: 9600 bits per second (bps)
Mold Temperature Controller (Qty 2): Addresses 1 and 2
Chiller (Qty 1): Address 1

Note in the above example that different device types may have the same address. This is because the SPI Protocol uses the device type as part of its internal address.

- D. NETWORK TROUBLESHOOTING:** Troubleshooting a network is best done by verifying the setup of each piece of equipment and insuring that the network is installed with the correct electrical interconnection. Here are some basic things to do if equipment isn't 'talking' as expected.
1. Verify that each piece of equipment is properly grounded to its power source.

2. Inspect cables inside and outside the electrical cabinet. Repair or replace as necessary. The cable scheme used by most manufacturers allows the communication signals to 'pass through' each piece of equipment. Therefore, when a piece of equipment is disconnected from the middle of the network, all the equipment 'after' that one will be disconnected, too. If a piece of equipment is being permanently removed, the device cables should be rearranged at the molding machine to reconnect the other equipment.
3. Check the Data Transfer Rate and Address of each piece of equipment. For example, if both Temperature Controllers have the same address, they will both try to 'talk' at the same time and garble each other's data.
4. Verify the network is properly terminated and that it is configured as a 'multi-drop'. This is best achieved by following the molding machine manufacturer's installation instructions and use extension cables provided by them or us.
5. Attach each device, singly, to the molding machine and see if it 'talks'. Add additional devices until a problem is seen.

SENTRA 'SK' Temperature CONTROLLER SPI COMMANDS

| POLL | | SELECT | | COMMAND | DESCRIPTION |
|------|----|--------|----|----------------|---------------------------------|
| C1 | C2 | C1 | C2 | | |
| 20 | 20 | 20 | 21 | Echo | Controller integrity command |
| 20 | 20 | | | Version | Controller version command |
| 20 | 30 | 20 | 31 | Setpoint | Desired process temperature |
| 20 | 32 | 20 | 33 | High temp | Hi temperature deviation alarm |
| 20 | 34 | 20 | 35 | Low temp | Low temperature deviation alarm |
| 20 | 36 | 20 | 37 | Flow Alarm | Low flow alarm setpoint* |
| 20 | 40 | | | Status Process | |

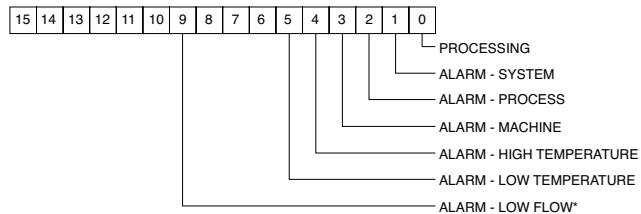

SENTRA 'SK' Temperature CONTROLLER SPI COMMANDS

POLL SELECT
C1 C2 C1 C2 COMMAND DESCRIPTION

20 42 Status Machine 1

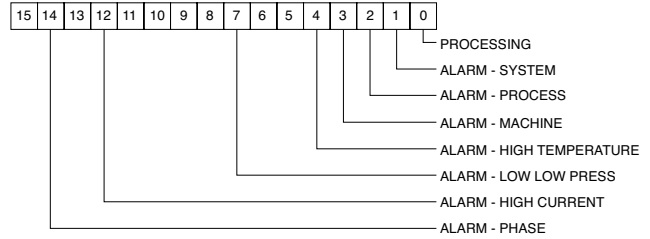

POLL SELECT
C1 C2 C1 C2 COMMAND DESCRIPTION

20 44 Status Machine 2

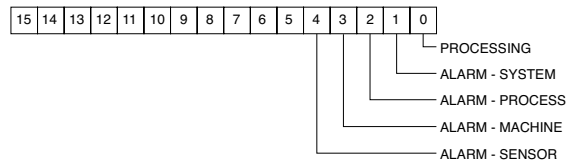

POLL SELECT
C1 C2 C1 C2 COMMAND DESCRIPTION

20 48 20 49 Machine

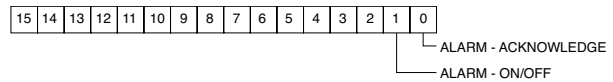

POLL SELECT
C1 C2 C1 C2 COMMAND DESCRIPTION

20 4A 20 4B Protected mode - machine

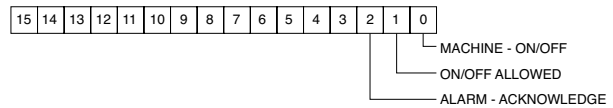

POLL SELECT
C1 C2 C1 C2 COMMAND DESCRIPTION

20 70 Temperature to process
 20 72 Temperature from process*
 20 78 Flow rate from unit GPM*
 20 E0 Blanket Poll
 Returns: 20 30 Setpoint
 20 32 High alarm deviation
 20 34 Low alarm deviation
 20 40 Status process
 20 70 To process temperature

8.8 COMMUNICATIONS CABLE

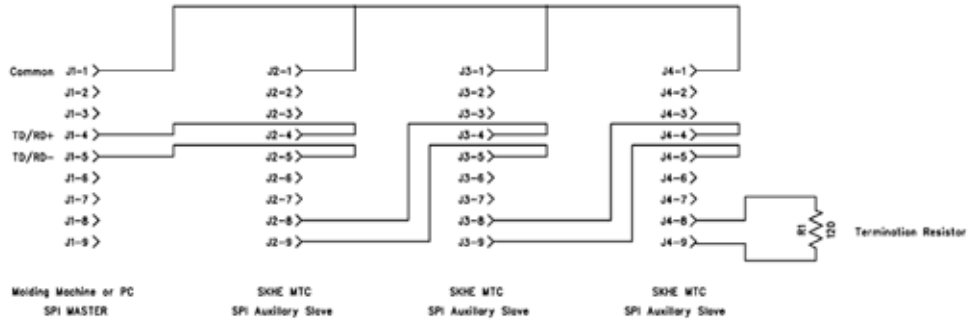

VERSION 3.01 MACHINE CONNECTIONS

PRIMARY MACHINE CONNECTIONS

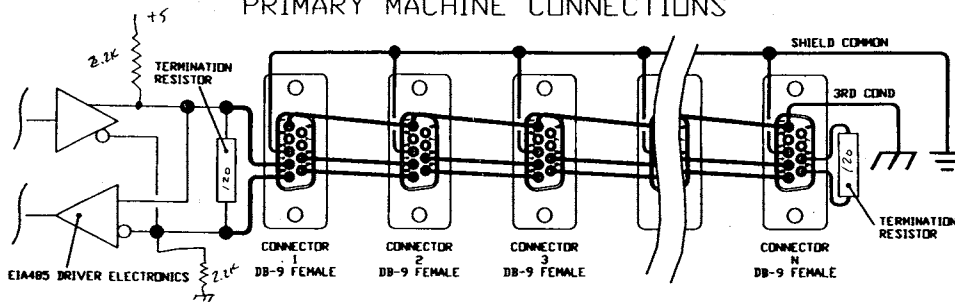

AUXILIARY MACHINE CONNECTIONS

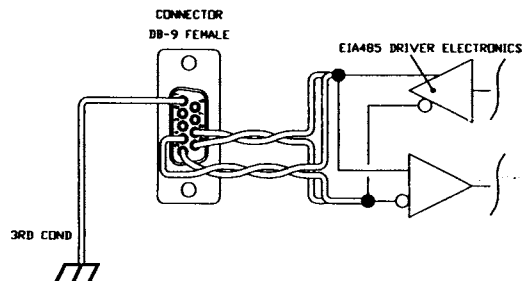

JUMPER PLUG

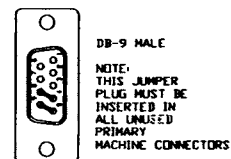

8.9 SECOND SETPOINT OPERATION

- A. The SENTRA SK instrument is available with optional second setpoint capability. The second setpoint is activated by a contact closure between the red and black wires on the remote cable. The remote adjustable setpoint is activated by the input of 0-10 volts.
- B. The instrument must be configured for second setpoint or remote setpoint before use. To access the extended configuration menu the second DIP switch (located on the top edge of the CPU board) must be toggled to the off position.
- C. To activate the second setpoint function use the select key to access the "SP2" prompt in the extended menu. With the up arrow select 'yes' to enable the second setpoint option.
- D. To activate the remote setpoint use the select key to access the "RSP" prompt in the extended menu. With the UP arrow select "yes" to enable the remote setpoint function.

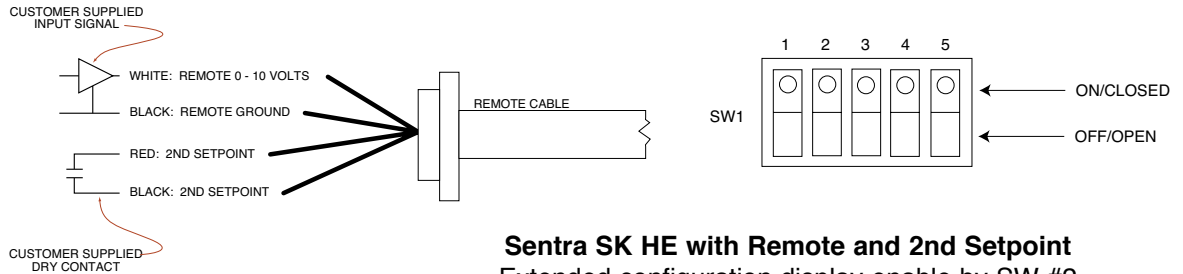

- | | | |
|-----|-------|------------------------------------------------|
| 1 | "AFL" | Alternate Flow Sensor |
| + - | 2 | "no" Internal - small flow sensor |
| + - | 3 | "yes" Alternate - large flow sensor |
| 1 | "Int" | NO, Internal, small flow Sensor selected |
| + - | 2 | "SSS" Calibration factor for small Flow sensor |
| 1 | "ALT" | YES, Alternate, large flow Sensor selected |
| + - | 2 | "LLL" Calibration factor for large Flow sensor |
| 1 | "SP2" | 2nd Setpoint Enable/Disable |
| + - | 2 | "no" Disable 2nd Setpoint |
| + - | 2 | "YES" Enable 2nd Setpoint |
| 1 | "rSP" | Remote Setpoint Enable/Disable |
| + - | 2 | "no" Disable Remote Setpoint |
| + - | 2 | "YES" Enable Remote Setpoint |

8.10 OPTIONAL ALARM OPERATION

- A. The **SENTRA HE** and **SENTRA LE** are standard with a 110 volt AC alarm output. The alarm output can be connected to customer provided alarm annunciation, plant-wide monitoring system or optional annunciation provided by **ADVANTAGE**.
- B. **BEACON ALARMS** used when both visual and audible alarm annunciation is needed. The **ADVANTAGE** beacon is an integral light and buzzer assembly to provide high visibility in a busy, noisy shop. The beacon will signal until the alarm condition is acknowledged by the operator.
- C. **AUDIBLE ALARMS** provide a loud signal when an alarm condition is present. The **ADVANTAGE** audible alarm is mounted on the front cover of the **SENTRA**.

CONDITIONS THAT TRIGGER AN ALARM OUTPUT ON MOLD TEMPERATURE CONTROLLERS

| CONDITION | CONTROLLER | |
|-----------------------------|------------|-----|
| | HE | LE |
| Incorrect 3Ø power entry | Yes | No |
| Pump overload tripped | Yes | Yes |
| High temperature fault | Yes | Yes |
| Water supply pressure fault | Yes | Yes |
| Temperature deviation | Yes | Yes |
| AVT valve malfunction | Yes | Yes |
| Sensor probe malfunction | Yes | Yes |

**BEACON AND AUDIBLE ALARMS ARE SILENCED
DURING AN ALARM CONDITION BY PRESSING
THE START BUTTON ON MICROPROCESSOR
CONTROLLER**

8.11 AVT™ VALVE COMPONENTS

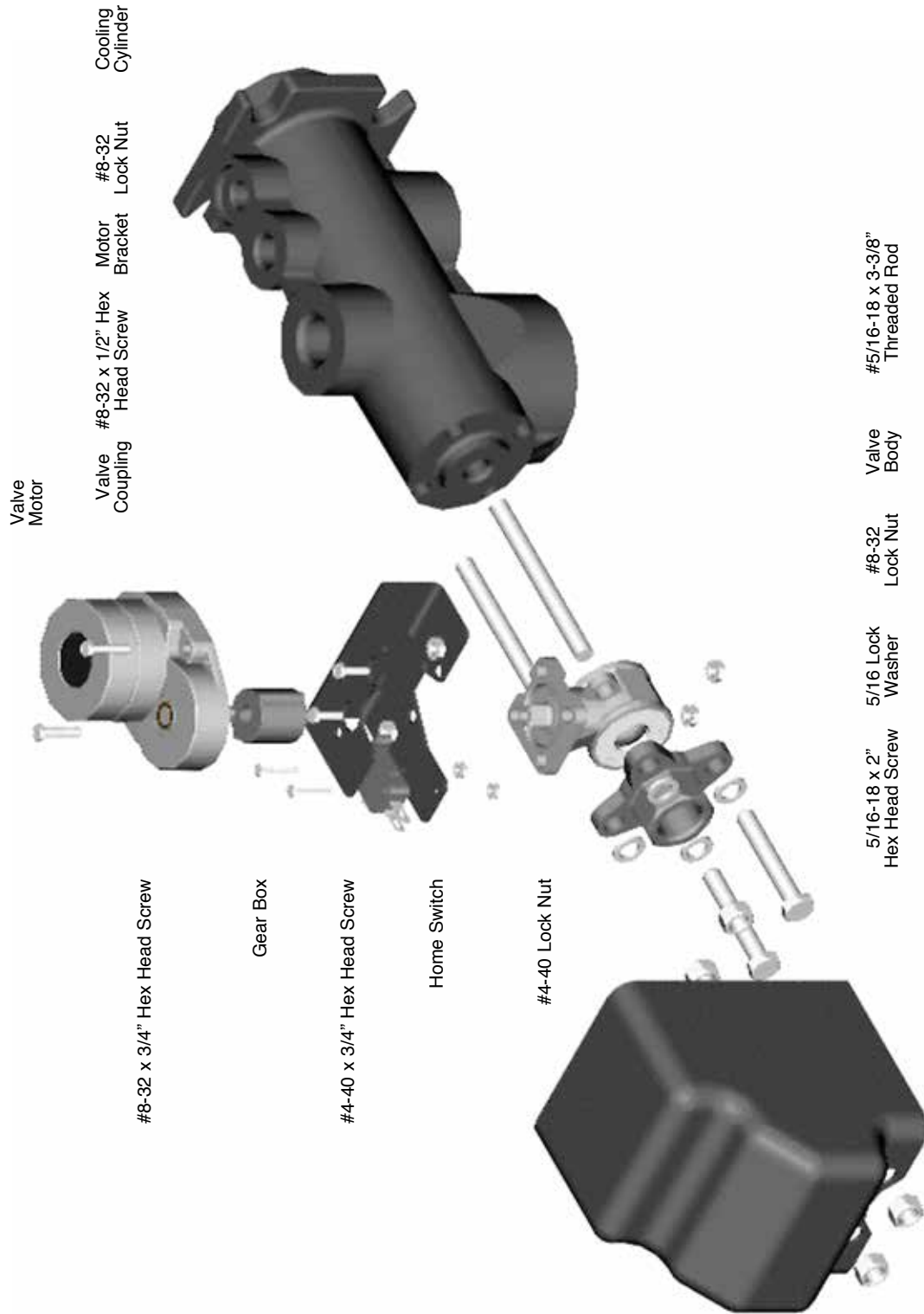

8.12 SENTRA AS5 PUMP PARTS LIST - 1/2 HP TO 1 HP

| PART # | DESCRIPTION |
|----------------|--------------------------------------------------|
| 6206995 | MOTOR/PUMP ASSEMBLY 1/2HP AS5 2/4/3/60 |
| 414 | Adapter - iron C2-4551 AS5 |
| 771599 | Pump case - iron D2-1839 AS5 |
| 3444400 | Tank gasket 2-3/8" A-9159 AS5 |
| 3444401 | Tank gasket 4-1/2" A2-8748 AS5 |
| 4310601 | Impeller B2-5264 4.37" AS5 |
| 4757861 | Motor AE5/AS5/A5W 1HP #S-2771R |
| 5486522 | Nut S-4989 AS5 |
| 5622271 | O-ring Case S-5091 AS5 |
| 6490000 | Shaft seal 101-173 5/8 EPT |
| 6491000 | Shaft seal EPT/Ceramic 4949 AE5/AS5 |
| 6207000 | MOTOR/PUMP ASSEMBLY AS5 3/4HP ODP 230/460 |
| 414 | Adapter - iron C2-4551 AS5 |
| 771599 | Pump case - iron D2-1839 AS5 |
| 3444400 | Tank gasket 2-3/8" A-9159 AS5 |
| 3444401 | Tank gasket 4-1/2" A2-8748 AS5 |
| 4310602 | Impeller B2-5264 4.5" AS5 |
| 4757862 | Motor AE5/AS5/A5W 3/4HP #S-2772R |
| 5486522 | Nut S-4989 AS5 |
| 5622271 | O-ring Case S-5091 AS5 |
| 6490000 | Shaft seal 101-173 5/8 EPT |
| 6491000 | Shaft seal EPT/Ceramic 4949 AE5/AS5 |
| 6207010 | MOTOR/PUMP ASSEMBLY AS5 1HP AS5 2/4/3/60 |
| 414 | Adapter - iron C2-4551 AS5 |
| 771599 | Pump case - iron D2-1839 AS5 |
| 3444400 | Tank gasket 2-3/8" A-9159 AS5 |
| 3444401 | Tank gasket 4-1/2" A2-8748 AS5 |
| 4310603 | Impeller B2-5264 4.75" AS5 |
| 4757863 | Motor AE5/AS5/A5W 1 HP #S-2773R |
| 5486522 | Nut S-4989 AS5 |
| 5622271 | O-ring Case S-5091 AS5 |
| 6490000 | Shaft seal 101-173 5/8 EPT |
| 6491000 | Shaft seal EPT/Ceramic 4949 AE5/AS5 |



8.13 SENTRA AS5 PUMP PARTS LIST - 1.5 HP TO 3 HP

| PART # | DESCRIPTION |
|----------------|-----------------------------------------------|
| 6207020 | MOTOR/PUMP ASSEMBLY AS5 1.5HP 2/4/3/60 |
| 414 | Adapter - iron C2-4551 AS5 |
| 771599 | Pump case - iron D2-1839 AS5 |
| 3444400 | Tank gasket 2-3/8" A-9159 AS5 |
| 3444401 | Tank gasket 4-1/2" A2-8748 AS5 |
| 4310604 | Impeller B2-5264 5.06" AS5 |
| 4757864 | Motor AE5/AS5/A5W 1-1/2HP #S-2774R |
| 5486522 | Nut S-4989 AS5 |
| 5622271 | O-ring Case S-5091 AS5 |
| 6490000 | Shaft seal 101-173 5/8 EPT |
| 6491000 | Shaft seal EPT/Ceramic 4949 AE5/AS5 |
| 6207030 | MOTOR/PUMP ASSEMBLY AS5 2HP 2/4/3/60 |
| 414 | Adapter - iron C2-4551 AS5 |
| 771599 | Pump case - iron D2-1839 AS5 |
| 3444400 | Tank gasket 2-3/8" A-9159 AS5 |
| 3444401 | Tank gasket 4-1/2" A2-8748 AS5 |
| 4310605 | Impeller B2-5264 5.25" AS5 |
| 4757865 | Motor AE5/AS5/A5W 2HP #S-2775R |
| 5486522 | Nut S-4989 AS5 |
| 5622271 | O-ring Case S-5091 AS5 |
| 6490000 | Shaft seal 101-173 5/8 EPT |
| 6491000 | Shaft seal EPT/Ceramic 4949 AE5/AS5 |
| 6207040 | MOTOR/PUMP ASSEMBLY 3HP AS5 2/4/3/60 |
| 414 | Adapter - iron C2-4551 AS5 |
| 771599 | Pump case - iron D2-1839 AS5 |
| 3444400 | Tank gasket 2-3/8" A-9159 AS5 |
| 3444401 | Tank gasket 4-1/2" A2-8748 AS5 |
| 4310605 | Impeller B2-5264 5.25" AS5 |
| 4757866 | Motor AE5/AS5/A5W 3HP #4551R |
| 5486522 | Nut S-4989 AS5 |
| 5622271 | O-ring Case S-5091 AS5 |
| 6490000 | Shaft seal 101-173 5/8 EPT |
| 6491000 | Shaft seal EPT/Ceramic 4949 AE5/AS5 |



8.14 SENTRA PARTS LIST - HE INSTRUMENT

| PART # | DESCRIPTION |
|---------|--------------------------------------------------|
| 299080 | AVT™ Drip Cover DWG MD-480 |
| 299081 | AVT™ Home Switch Bracket DWG MD-468 |
| 781000 | Caster 2" Swivel #EY459R |
| 1835050 | Contactora 3030APS 30 AMP |
| 1843600 | AVT™ coupling DWG MD-464 |
| 2735358 | Sentra Top SS DWG EP-103 |
| 2746237 | SK Cabinet DWG #EP-103 |
| 2746238 | Electrical Enclosure Door SS DWG EP-103 |
| 2761201 | Electrical Sub Panel DWG EP-103 |
| 2851112 | Gauge Panel DWG EP-103 |
| 2877542 | Base DWG EP-103 |
| 3581000 | Pressure Gauge 0-160 PSI 2" Face |
| 3708505 | Plastic Handle P2-41 |
| 3775510 | Heater 10kw 2/4/3/60 Square Flange |
| 3520005 | Heater Flange Gasket 4.5" OD |
| 4440100 | Instrument Kit Complete Sentra 2000HE #247200 |
| 752000 | Remote Display Cable 20ft #239920 |
| 752976 | Cable Kit for Oversize Units #247402 |
| 4360096 | Temperature Sensor, Threaded Body #910500 |
| 4405004 | Three Phase Sensor #934100 |
| 4406003 | Temp Sensor / High Temp Limit #230400 |
| 4406013 | SK-HE AVT™ / Flow Sensor Cable #979800 |
| 4406014 | SK-HE Probe Cable #979900 |
| 4406015 | SK-HE AC Cable #979700 |
| 4440002 | Sentra 2000HE Instrument Only #239300 |
| 4440097 | Instrument MK / RK / SK-HE #239300 |
| 4440099 | Remote Display #239600 |
| 7163580 | Electronic Filter "Quench Arc" #933400 |
| 6207000 | Motor / Pump Assembly AS5 3/4HP ODP 230/460 |
| 414 | Adapter Iron C2-45551 AS5 |
| 771599 | Pump Case Iron 137-001-166 AS5 |
| 3444400 | Tank Gasket 2-2/3" A-9159 AS5 |
| 3444401 | Gasket, Tank Flange 4-1/2" AS5 |
| 4310602 | Impeller B2-5264. 4.5" AS5 |
| 4310611 | Impeller AS5 #100345 4.5" MFG after 2-97 |
| 4714466 | Motor 3/4HP 113-000-354T 2/4/3/60 |
| 4757862 | Motor AE5 / AS5 / A5W 3/4HP #S-2772R |
| 5486522 | Nut S-4989 AS5 |
| 5622271 | O-Ring Case 116.000.252 |
| 6490000 | Pump Seal Niresist 5/8" |
| 6491000 | Pump Seal Ceramic 5/8" |
| 6748201 | Cap Screw #102RO3A2 |
| 9118502 | Impeller Washer #100301 |
| 6671005 | Ring 304SS Flow Meter Mount |
| 6745560 | Rotor / Magnet 4 Pole with Bronze Bearing |
| 6930100 | Flow Sensor #17762N |
| 7274530 | Spindle 303SS |
| 7370000 | Motor Starter CR35AB3AA1B |
| 1733456 | Auxiliary Contact Kit #353XAAA |
| 7541100 | Panel Mount Pressure Switch #82681 |
| 7732250 | Heater Cylinder AS5 #D2-1841 |
| 7732260 | Cooling Cylinder AS5 #D2-1840 |
| 8240000 | Transformer 9T58B42 |
| 8764949 | AVTTM Drive Kit for 3/8" and 5/8" Valves #977700 |
| 8764950 | AVTTM Valve Body with Coupling 3/8" |
| 9060000 | Pressure Relief Valve 150# |

END

© 2014 ADVANTAGE ENGINEERING, INC.

RE 10/02/2014

